



HaiKoo®

User Guide



Original User Guide



TABLE OF CONTENTS

GENERAL INFORMATION	1
1. OBEY THE LEGAL REGULATIONS AND THE APPLICABLE RULES!	1
2. INTENDED USE	1
3. NOT-INTENDED USE	1
4. LIABILITY	1
5. PERSONNEL QUALIFICATIONS	1
6. INFORMATION ABOUT THE RESIDUAL RISKS - USED SAFETY SIGNS	1
7. DISMANTLING, STORAGE, TRANSPORT	2
8. THE LEVEL OF NOISE EMISSION	2
9. MAIN SWITCH	2
10. PROTECTION	2
GENERAL SAFETY RULES	3
OPERATOR'S GUIDE	4/5
OPERATOR'S GUIDE "CAGES"	6/7
MAINTENANCE INSTRUCTIONS	8
TROUBLE SHOOTING GUIDE	9/10
DECLARATION OF INCORPORATION OF PARTLY COMPLETED MACHINERY	
EC-DECLARATION OF CONFORMITY	

Disclaimer

The original, authoritative version of this manual is the English version produced by ROXELL BV. Subsequent changes to any manual made by any third party have not been reviewed nor authenticated by Roxell. Such changes may include, but are not limited to, translation into languages other than English, and additions to or deletions from the original content. Roxell disclaims responsibility for any and all damages, injuries, warranty claims and/or any other claims associated with such changes, in as much as such changes result in content that is different from the authoritative Roxell-published English version of the manual. For current product installation and operation information, please contact the customer service and/or technical service departments of Roxell. Should you observe any questionable content in any manual, please notify Roxell immediately in writing to: ROXELL BV - Industrielaan 13, 9990 Maldegem - Belgium.

General information

! **IMPORTANT:** These instructions must be read, understood and all points observed by the user, the responsible and operating personnel.

Obey the legal regulations and the applicable rules

This concerns, among other things, the European regulations and directives transposed into national legislation and/or the laws, safety and accident prevention regulations that apply in the user's country.

During assembly, operation and maintenance of the installation the legal regulations concerned and the applicable technical rules must be obeyed.

Intended use

The installation has been designed solely for intensive livestock use and has been developed according to the applicable rules of good workmanship. Extra loading of the product is therefore prohibited. Any other use is considered to be improper use. The manufacturer is not responsible for damage resulting therefrom. The user bears sole responsibility. The manufacturer can determine from the system data whether the product was used in accordance with the specified use.

Not-intended use

All use different than described in [Intended Use](#) is at the responsibility of the end user.

Liability

The (extended) warranty will not apply if any of the following has occurred: failure by the customer to inspect the delivered goods and report visible defects within 8 days of delivery with respect to the products, improper handling, transportation, modification or repair; accidents, defective or improper use; improper or defective assembly, installation, connection or maintenance (having regard to Roxell's most current assembly, installation, connection and maintenance manuals); improper modifications or manipulations of the operating system, hardware or any other software of the product by the customer; force majeure; negligence, lack of supervision or of maintenance on the part of customer; normal wear and tear; use of cleansing agents and disinfectants that are excluded in Roxell's most current use and maintenance manuals; use of cleansing agents and disinfectants in violation with the instructions received from the suppliers; or use of the products in an ATEX- surrounding.

The (extended) warranty shall not apply in the event of a defect caused either by materials or accessories supplied by or services rendered by the customer; or by an intervention by a person or entity which is not authorized or qualified for carrying out such intervention. Furthermore, the (extended) warranty will only apply if the products are used in livestock houses and if all parts or components of the products are supplied by Roxell.

Roxell will not be liable for any damages caused due to improper or defective use, assembly, installation, connection or maintenance of the products. In this respect, the customer expressly acknowledges that (i) all use, assembly, installation, connection or maintenance must be done in accordance with Roxell's most current assembly, installation, connection and maintenance manuals and (ii) the electrical installation on which the products must be connected must be done in accordance with applicable local legislation on electrical installations. Furthermore, the products must be tested both mechanically and electrically by the customer in accordance with state of the art techniques and applicable local legislation.

Personnel qualifications

User

The person who uses a function or operation of a product for their work or who works on the product. The user must be able to read the instructions for use and fully understand them. The user has knowledge of the functioning and construction of the installation.

Technically trained person

An expert who can assemble and maintain the installation (**mechanically/electrically**), and resolve malfunctions. On the basis of his/her technical training and experience, he/she has sufficient knowledge to be able to assess activities, recognize possible dangers and rectify dangerous situations.

Storage

Put all parts to be assembled in a room or at a location where the not yet assembled components are protected against weather influences.

Transport

Depending on the size of the parts and according to local circumstances and local legislation, the parts of the machine have to be transported with a forklift.

The forklift must be operated by a qualified person and in accordance with the rules of good workmanship. When lifting the load, always check if the center of gravity of the load is stable.

Dismantling

Dismantle the installation and its components in accordance with the environmental legislation of the country or the local authorities applicable at that time. All functioning products and exchange parts must be stored and disposed of in accordance with the applicable environmental regulations.

Environmental information for customers in the European Union

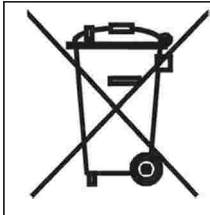

The European legislation requires that equipment marked with this symbol on the product or packaging must not be collected with unsorted household waste. This symbol indicates that the waste electrical and electronic equipment (WEEE) cannot be disposed of in the regular household waste. We highly recommend that you bring your product to an official collection point so that an expert can remove the waste electrical and electronic equipment. Inform yourself of local legislation on separate collection of waste electrical and electronic equipment. Respect the local regulations and never dispose of the product together with household waste.

Information about waste disposal - electrical/electronic material for companies

1. In the European Union

If you have used the product for commercial purposes and you want to dispose of it, contact Roxell, who will give you information about the return of the product. It is possible that you will have to pay a disposal charge for the return and recycling. Small products (and small quantities) can be processed by the local collection agencies.

2. In other countries outside the European Union

If you want to dispose of this product, contact the local authorities for information concerning the correct disposal procedure.

The level of noise emission

The noise level of the installation in operation does not exceed 70 dB(A).

LOTOTO = Lock Out - Tag Out - Try Out

Before you begin: Everyone needs his own lock and tag (label), which can't be removed by other persons. Inform all the persons who are influenced by the procedure.

1 To block

- Localize all sources of energy (electric, hydraulic, pneumatic).
- Switch off.
- Take the relevant installation or process out of operation and lock it against reuse. You can do this by placing a padlock or other blocking mechanism (Lock Out).

2 To mark

Attach a sign, label or sticker to the padlock or blocking mechanism to reveal the nature and the expected duration of the work to other persons (Tag Out).

3 To check

- Check if the source of energy is switched off.
- Remove any remaining energy.
- Check that the installation or process is actually safe (Try Out).

Use personal protective equipment

Ensure you wear personal protective equipment (gloves, dust masks...).

Illuminance - sufficient lighting

- **A minimum illuminance of 200 lux is necessary** during usage, maintenance and installation.
- Provide at the installation **(portable) emergency lighting in case of power failure**.

Electrical equipment, control panels, components and drive units







- To operate control panels, there must be **at least 70 cm of free space**.
- Control panels must **always remain closed**. The key of the control panel must be in possession of an authorized person. Only an electrically trained person (see above) shall carry out maintenance activities inside the control panels.
- The necessary measures must be taken by the user to keep out **rats, mice and other vermin from the control panels**.
- If electrical equipment, control panels, components and drive units are damaged, the system must be stopped **immediately!**
- Electrical equipment, control panels, components and drive units should **never be sprayed with water or other liquid!**
- Electrical equipment, control panels, components and drive units should **never be covered with any material**.

Information about the residual risks - used safety signs

There are three levels of danger, which you can recognize from the following signal words:

- **DANGER**
- **WARNING**
- **CAUTION**

The nature and source of the imminent danger and possible consequences of not obeying warnings is stated here!

Symbol	Meaning
	DANGER indicates a direct imminent danger that can result in a serious or even fatal accident if the safety measures are not respected.
	WARNING indicates a possible imminent danger that can result in a serious accident or damage to the product if the safety measures are not respected.
	CAUTION indicates possible, dangerous situations that can result in minor physical injury or material damage if the safety measures are not respected.
	This symbol refers to supporting information.
	Allowed
	Not allowed
	This symbol will be used to draw your attention to matters that are of great importance for your safety. It means: warning - follow the safety instructions. Disconnect the current and read the safety rules. In short: be alert. Ignoring these instructions can cause serious injuries or even death.

GENERAL SAFETY RULES

Minimax/HaiKoo/Comeo Nr: 002.../009.../001

Automatisch pannen voedersysteem voor vleestkuijens

Automatic pan feeding system for broilers

Winching systeem

Liersysteem voor voer- en drinklijnen

Winching system for feed- and drink lines



DANGER

IMPORTANT

Carefully read the following instructions before
USING the system

1. Before you do any **repair**, or **maintenance works**, always **disconnect the electricity supply**.
2. Ensure you wear **personal protection equipment** (gloves, dust masks).
3. The system **starts automatically**.
Never use your **hands** at **dangerous locations** (feed intake boots, drive units, control units or outlet holes in the tubes) before you have **completely switched off** the transport system and made sure that **nobody** can **switch it on** without your knowledge.
4. **Never** allow **unauthorized persons** to **enter the house** in your absence.
5. **Be careful** when **lowering** or **winching** up the feeding lines/circuits :
 - **stop** immediately at the slightest hitch.
 - **never** stay **underneath** when lowering or winching up the lines/circuit.
6. If the auger stalls : **immediately** switch **off** the system. Carefully read the trouble shooting guide and strictly follow instructions. Contact a **technically trained person**.
An auger **under tension** can **cause very serious injuries** when released.
7. Regularly check the **elbow/trough and/or tube connections**. Tighten if necessary.
8. Ensure that the **hopper cover (grill)** or **cover** on the 100 kg hopper **closes properly**.
9. Regularly check that the **control unit (pan)** and/or the **motor handy box** are properly closed.



This **SYMBOL** will be used to draw your attention to matters that are of **GREAT IMPORTANCE** for your **SAFETY**.

It means : **WARNING** - follow the safety instructions :
disconnect the current - re-read the safety rules.

In short : **BE ALERT**. **IGNORING** these instructions can cause **SE-RIOUS INJURIES** or even **DEATH**.

For floor feeding - from day-old chicks to broilers

AVOID FEED WASTAGE = ADJUST FEEDER HEIGHT

EASY START

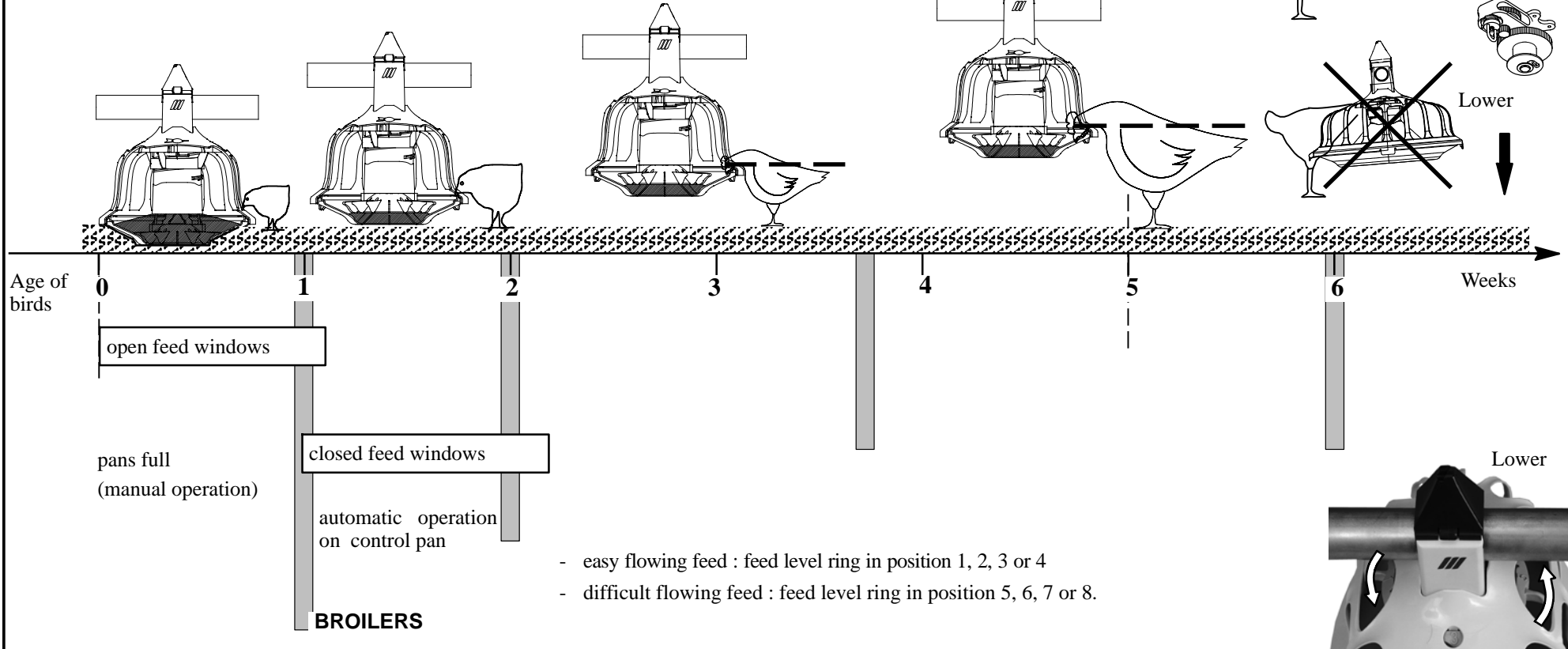

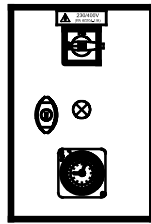

For controlled feeding : have the pans emptied once (to several times) a day.

Number of birds per pan (heavy birds/light birds) (poor ventilation/good ventilation)

Broilers 50-91 (max 150kg/pan)

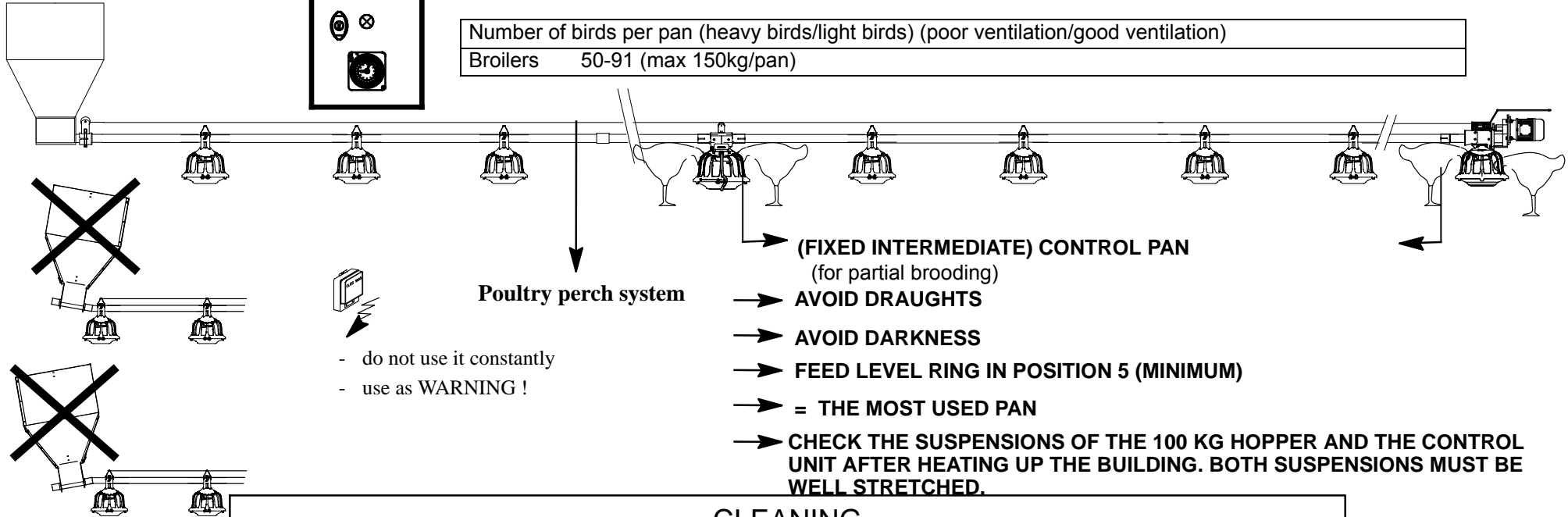

CLEANING

- * The last day : run the tubes empty and let the birds empty the pans as much as possible.
- * Collect the feed residues by opening all pans, and empty them.
- * Protect electrical components against water.
- * Clean the whole system by means of a high- pressure cleaner (max. 100 Bar).
- * When using aggressive detergents or disinfectants consult your supplier.

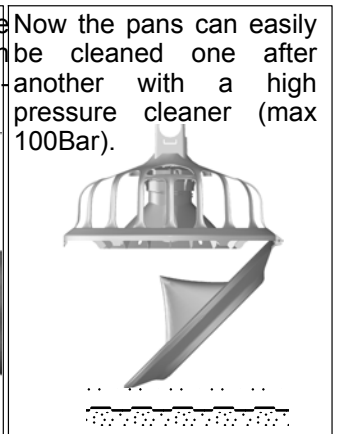
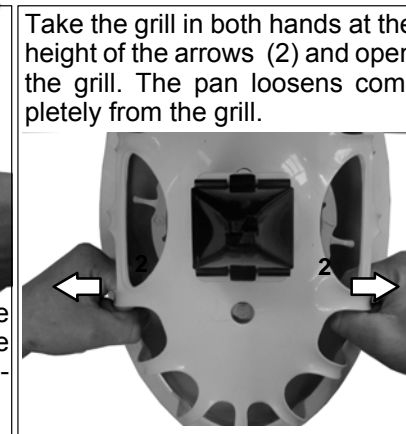
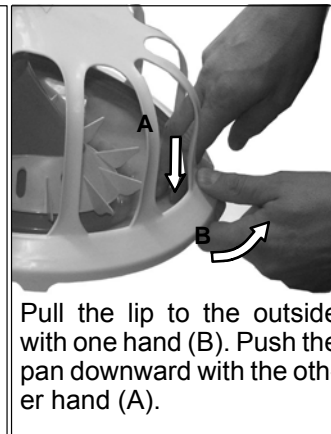
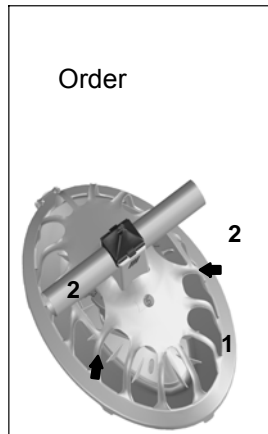

For cage feeding - from day-old chicks to broilers

AVOID FEED WASTAGE = ADJUST FEEDER HEIGHT

EASY START

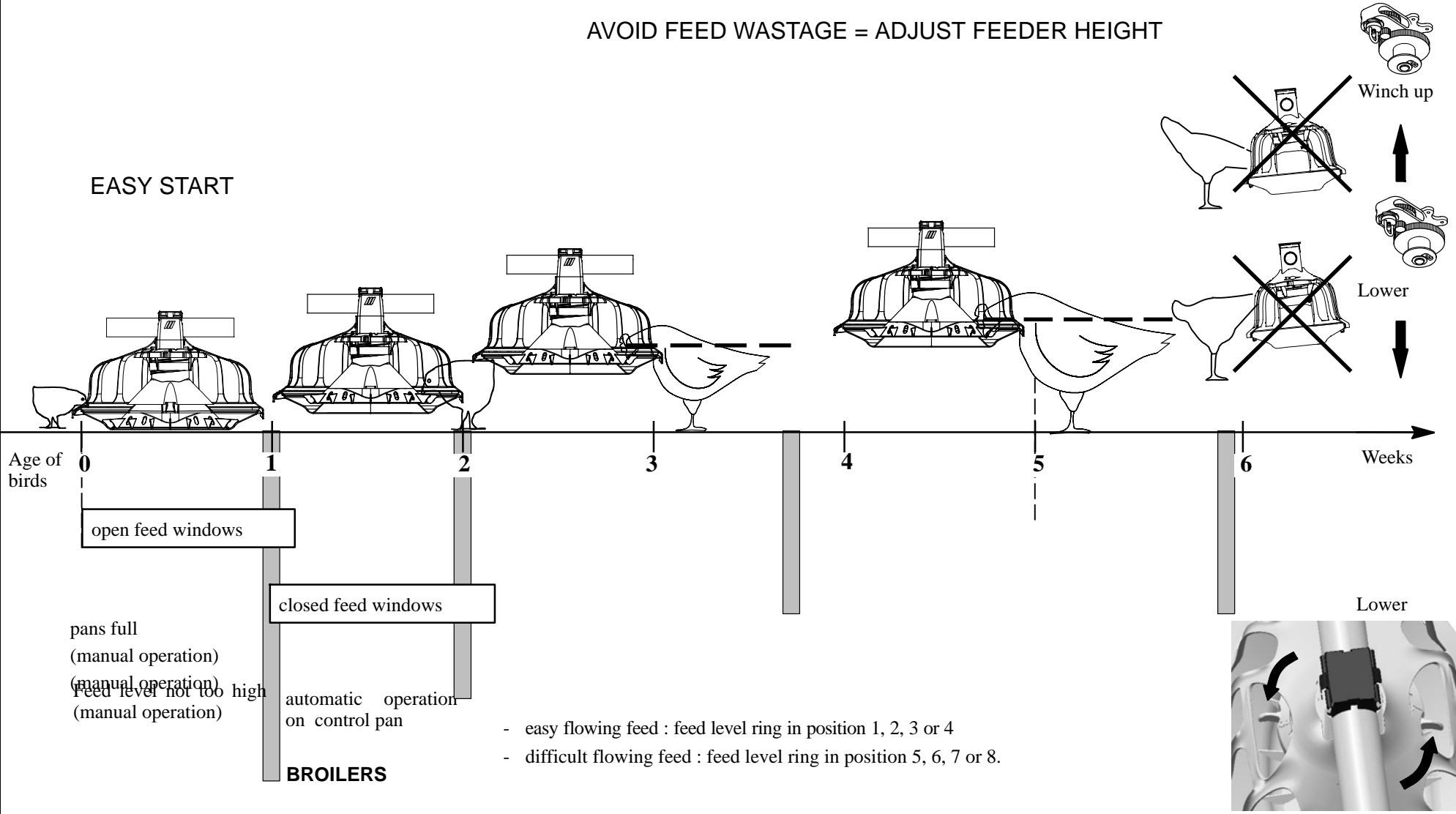

- easy flowing feed : feed level ring in position 1, 2, 3 or 4
- difficult flowing feed : feed level ring in position 5, 6, 7 or 8.

HaiKoo CAGES

OPERATOR'S GUIDE

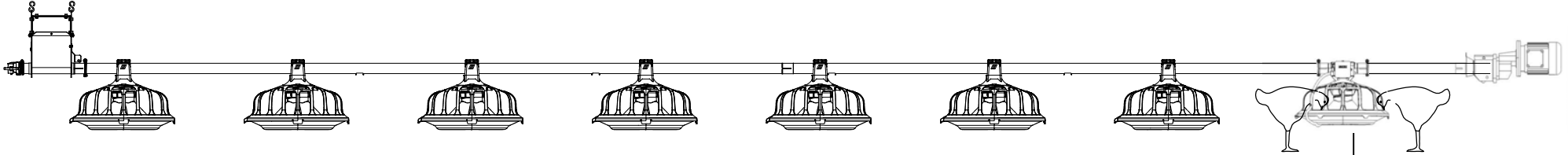

Number of birds per pan (heavy birds/light birds) (poor ventilation/good ventilation)	
Broilers	50-91 (max 150kg body weight/pan)

CONTROL PAN

- ➔ AVOID DRAUGHTS
- ➔ AVOID DARKNESS
- ➔ FEED LEVEL RING IN POSITION 5 (MINIMUM)
- ➔ = THE MOST USED PAN

CLEANING

- * The last day : run the tubes empty and let the birds empty the pans as much as possible.
- * Collect the feed residues by opening all pans, and empty them.
- * Protect electrical components against water.
- * Clean the whole system by means of a high-pressure cleaner (max. 100 Bar).
- * When using aggressive detergents or disinfectants consult your supplier.

Order

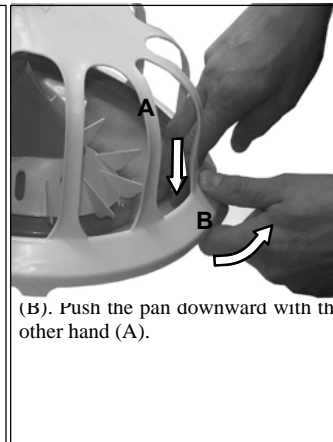
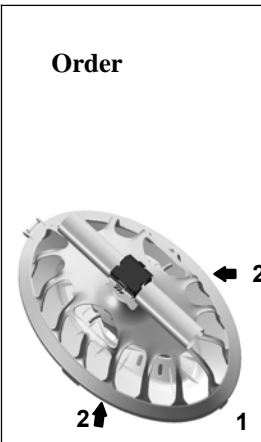

Take the grill in both hands at the height of the **arrows (2)** and open the grill. The pan loosens completely from the grill.

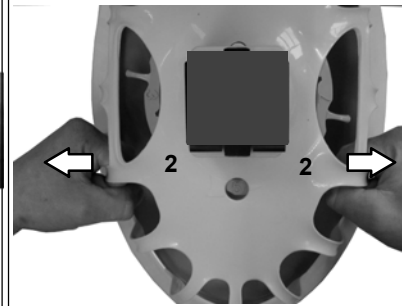

Now the pans can easily be cleaned one after another with a high pressure cleaner.

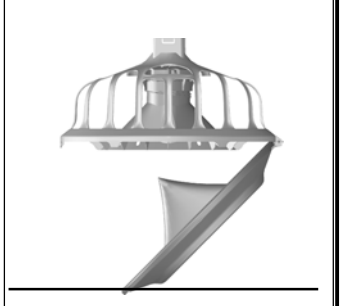

MAINTENANCE INSTRUCTIONS				
 DANGER	Switch off the main switch first. Use personal protective equipment.	3-monthly	6-monthly	Yearly
ACTIONS IN GREY BACKGROUND MUST BE DONE BY A TECHNICALLY TRAINED PERSON.				
1. Power unit				
- Make fan dust-free				X
- Check possible damages to electrical wiring				X
2. Poultry intake boot with sensor				
- Check sensor				X
3. 100kg hopper (lines)				
- Check level switch				X
4. Suspension				
- Check operation of (central) winch	X			
- Check operation of (central) winch. Grease after cleaning.				X
- Check connection of cable	X			
- Check connection of pulleys	X			
- Check suspension of tubes and motors	X			
- Keep suspension cord/cable in tension	X			
5. Poultry perch cable above the tubes/elbows				
- Check cable				X
6. Pans				
- Check possible damages of pans				X
7. Sensors/switches				
- Check operation of safety switch or sensor.		X		
- Check electrical wiring				X
8. Control pan				
- Remove the pan and clean the inside tube				X
- Clean (dry) sensor head and central tube				X
- Check switch of control units				X
9. Lines/circuits				
- Check screws and bolts in the system after the first month and after each batch . Tighten if necessary.	X			
- Keep tubes level.	X			
- Remove all feed from the system when the system will be out of use for a period.	X			

TROUBLE SHOOTING GUIDE



DANGER

**Switch off the main switch first.
Use personal protective equipment.**

ACTIONS IN GREY BACKGROUND MUST BE DONE BY A TECHNICALLY TRAINED PERSON.		
PROBLEM	CAUSE	CORRECTIVE ACTION
1. None of the feeder lines run.	No current.	Replace defective fuses or reset circuit breakers. Check current supply to the house.
	Defective time clock.	Replace defective clock.
	Time clock not properly set.	Readjust tabs.
2. One/more lines do not run. Pans are empty	Wires from motor damaged.	Measure current in motor wires. Replace wires if defective.
	Motor protection switched off.	See points 3. & 4. Reset motor overload button.
	Defective sensor in the control unit, or sensor not properly adjusted.	Check the good operation of the sensor. Replace if necessary.
	Control unit not functioning properly.	Put the feed level ring in a higher position. Hang an extra lamp above it. Check temperature. Control unit must be the most attractive one, especially the control unit of the feeder line below the Flex-Auger control unit.
	The control unit does not function properly when the feed windows are open	Check the motor suspension. Hang the motor horizontally. Make sure that the main cable is stretched.
	Defective sensor/minimum switch control unit or 100kg hopper.	Check control unit sensor or switch. Replace if necessary.
3. Motor is often overloaded.	Oil on auger overloads the motor.	Clean the auger by running repeatedly 25kgs of feed through the line.
	Not enough current supply to the motors.	Check current supply at motor location. Start the motor. Measure start current on motors. Wiring must be thick enough to guarantee good operation of the system.
	Object blocks the auger. Motor runs, then stalls. Feed sticks to the tubes.	Check if there are no objects in the boot, the control unit and the drop holes of the feeder pans. Remove any objects.
4. Auger stalls.	Anchor bearing worn out or broken.	Replace bearing. Gently slide auger back into the tubes. Don't let it jump back : your finger or the bearing could be damaged .
	Auger not enough stretched.	Shorten the auger.
	Object blocks the auger.	Remove the object.
5. Tubes / boot wear rapidly, much noise when system runs.	Auger kinked or bent at the wear point. Auger end overlaps the anchor end.	Make sure not to kink the auger when using gripping pliers. Auger must not overlap the anchor end.
6. Not enough feed supplied to fill up the lines.	Flex-Auger drop holes are too small or point upwards.	Make holes wider/turn tubes with holes downwards.
	Flow regulator in boot of feed supply system blocks passage of the feed.	Adjust flow regulator to get a higher capacity.
	Flex-Auger capacity is too low.	Check the capacity of the Flex-Auger according the specifications. Check the installation of the Flex-Auger.
	Not enough time set on the time clock.	Extend operation time per meal.
7. Feed drops directly on the adjuster ring of the grill.	Pan not installed over the hole.	Remove the top support. Install the pan ass'y over the hole and the lips.

PROBLEM	CAUSE	CORRECTIVE ACTION
Windows are open and feed level is too low.	Some windows are actually closed.	Adjust height of feeder line until all windows completely open and close simultaneously.
Windows are closed and feed level is too high.	Adjuster ring set too high.	Adjust height. See OPERATOR'S GUIDE.
	Not all windows are closed or completely closed.	Adjust height of feeder line until all windows completely open and close simultaneously.
Windows are closed and feed level is too low.	Adjuster ring set too low.	Adjust height. See OPERATOR'S GUIDE.
	Feeder line not winched up high enough.	Winch up feeder line higher until all pans simultaneously are clear of the litter.
Hopper 1 is empty while the feed level in the second hopper corresponds with the position of the level switch.	Birds massively move to one side of the house, i.e. depending upon the position of the sun.	<p><u>The problem occurs sporadically:</u></p> <p>You can solve the problem by changing the round hole in the Flex-Auger tube above hopper 1 into a rectangular one. Install two outlet drops above hopper 1 (see fig. 3.) if necessary, so that more feed drops into hopper 1. Install the level switch low in hopper 2 (see fig. 2.). Install and adjust drop tubes to all hoppers high enough.</p> <p><u>The problem occurs regularly:</u></p> <p>Install a level switch high in each hopper. Install the level switch low in the last hopper. Install and adjust the drop tube high, so that the feed in tube A (over switch level) is carried to hopper 2.</p>

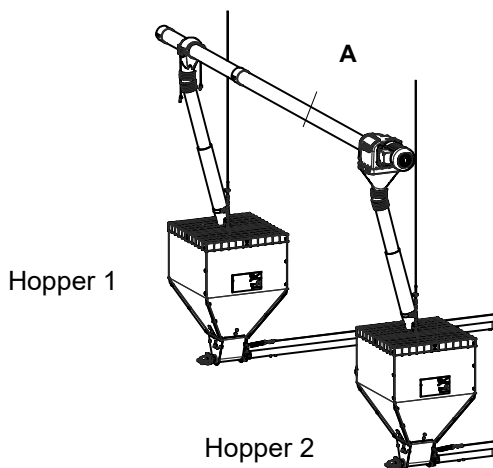

FIGURE 1.

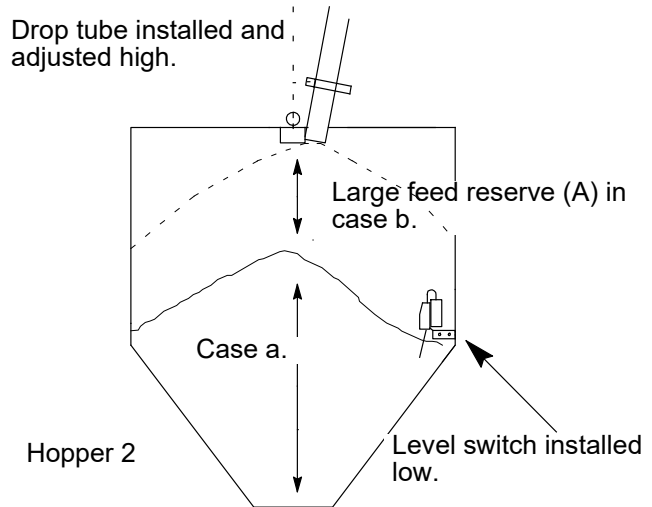

FIGURE 2.

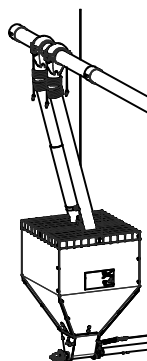

FIGURE 3.



Inbouwverklaring betreffende niet voltooide machines (Richtlijn 2006/42/EG, Bijlage II.1.B)
Declaration of incorporation of partly completed machinery (Directive 2006/42/EC, Annex II.1.B)

Fabrikant/Manufacturer:
Roxell BV, Industrielaan 13, 9990 Maldegem
Tel: +32 50 72 91 72
Fax: +32 50 71 67 21

Verklaart geheel onder eigen verantwoordelijkheid dat het product:
Declares on its own responsibility that the product:

MiniMax/HaiKoo/CoMeo Nr: 001.../002.../009...
Automatisch pannen voedersysteem voor vleeskuikens.
Automatic pan feeding system for broilers.

Waarop deze verklaring betrekking heeft, in overeenstemming is met:

- de volgende richtlijnen: 2006/42/EG (Machinerichtlijn); 2014/30/EU (Elektromagnetische Compatibiliteit);
- de geharmoniseerde Europese Normen: EN ISO 12100:2010; EN ISO 13854:2019; EN ISO 13857:2019; EN IEC 60204-1:2018; EN IEC 61439-1:2021; EN IEC 61439-2:2021.

Het is verboden bovengenoemd product in gebruik te stellen voordat de machine waarin het wordt ingebouwd in overeenstemming met de bepalingen van de Machinerichtlijn is verklaard.

Tevens verbindt de fabrikant (of zijn gemachtigde) zich om op met redenen omkleed verzoek van de nationale autoriteiten de relevante informatie over deze niet voltooide machine door te geven. De wijze van doorgifte is digitaal. De wijze van informatieverstrekking laat de intellectuele-eigendomsrechten van de fabrikant van de niet voltooide machine onverlet.

(NL)

Relating to this declaration is in accordance with

- The following directives 2006/42/EC (Machinery Directive); 2014/30/EU (Electromagnetic Compatibility).
- The harmonised European standards: EN ISO 12100:2010; EN ISO 13854:2019; EN ISO 13857:2019; EN IEC 60204-1:2018; EN IEC 61439-1:2021; EN IEC 61439-2:2021.

This product must not be put into service until the machinery into which it is to be incorporated has been declared in conformity with the provisions of the Machinery Directive.

The manufacturer (or its agent) also undertakes, at the duly reasoned request of the national authorities, to provide the relevant information concerning this partly completed machinery. The method of transmission will be digital. The manner in which the information is provided does not prejudice the manufacturer's intellectual property rights concerning the partly completed machinery.

(EN)

00105304

Plaats, Datum / Place, Date: Maldegem, 01/01/2023

.....
Dhr. Gino Van Landuyt
Managing Director

"This part may only be filled out if all built-in subparts are delivered by Roxell"

EG-verklaring van overeenstemming (Richtlijn 2006/42/EG, Bijlage II.1.A)
EC-declaration of conformity (Directive 2006/42/EC, Annex II.1.A)

Wij/We _____

(naam installateur/name fitter)

(volledig adres en land/complete address)

Verklaren geheel onder eigen verantwoording de
Declare completely on own justification that

(naam machine/name machinery)

(nummer CE-label/number CE-label)

In een installatie te hebben ingebouwd geheel volgens de Roxell-voorschriften en in overeenstemming met de bepalingen van de Machinerichtlijn.

Has been incorporated in conformity with the provisions of the Machinery Directive and the prescriptions of Roxell BV.

(plaats, datum/place, date)

(naam, handtekening/name, signature)

De EG-verklaring van overeenstemming / inbouwverklaring betreft uitsluitend de machine of niet voltooide machine in de toestand waarin zij op de markt is gebracht, met uitsluiting van de later bijvoorbeeld door de verdeler en/of installateur en/of eindgebruiker toegevoegde componenten en/of verrichte bewerkingen.

The EC-declaration of conformity / declaration of incorporation relates exclusively to the machinery or partly completed machine in the state in which it was placed on the market and excludes components which are added and/or operations carried out thereafter for instance by the distributor and/or the installer and/or the final user.



XXXXXXXX

UK Declaration of Incorporation of partly completed machinery
Supply of Machinery (Safety) Regulations 2008

Manufacturer:

Roxell BV, Industrielaan 13, 9990 Maldegem

Tel: +32 50 72 91 72

Fax: +32 50 71 67 21

Declares on its own responsibility that the product:

MiniMax/HaiKoo/CoMeo Nr: 001.../002.../009...

Automatic pan feeding system for broilers.

Relating to this declaration is in accordance with the essential requirements of

- The following Statutory Instruments:
 - o Supply of Machinery (Safety) Regulations 2008
 - o Electromagnetic Compatibility Regulations 2016
- The following Designated standards:

BS EN ISO 12100:2010; BS EN ISO 13854:2019; BS EN ISO 13857:2019;
BS EN IEC 60204-1:2018; BS EN IEC 61439-1:2021; BS EN IEC 61439-2:2021.

This product must not be put into service until the machinery into which it is to be incorporated has been declared in conformity with the provisions of the Machinery Directive.

The manufacturer (or its agent) also undertakes, at the duly reasoned request of the national authorities, to provide the relevant information concerning this partly completed machinery. The method of transmission will be digital. The manner in which the information is provided does not prejudice the manufacturer's intellectual property rights concerning the partly completed machinery.

Place, Date: Maldegem, 01/01/2023

.....
Dhr. Gino Van Landuyt
Managing Director

"This part may only be filled out if all built-in subparts are delivered by Roxell"

UK Declaration of Conformity
Supply of Machinery (Safety) Regulations 2008

We _____
(name installer)

(complete address)

Declare completely on own justification that

_____ (name machinery) (number UKCA-marking)

has been incorporated in conformity with the provisions Supply of Machinery (Safety) Regulations 2008 and the prescriptions of Roxell BV.

_____ (place, date) (name, signature)

The UK Declaration of Conformity / Declaration of Incorporation relates exclusively to the machinery or partly completed machine in the state in which it was placed on the market and excludes components which are added and/or operations carried out thereafter for instance by the distributor and/or the installer and/or the end user.



EG-verklaring van overeenstemming (*Richtlijn 2006/42/EG, Bijlage II.1.A*)
EC-declaration of conformity (*Directive 2006/42/EC, Annex II.1.A*)

Fabrikant/Manufacturer:
 Roxell BV, Industrielaan 13, 9990 Maldegem
 Tel: +32 50 72 91 72
 Fax: +32 50 71 67 21

Verklaart geheel onder eigen verantwoordelijkheid dat het product:
 Declares on its own responsibility that the product:

Winching system Nr: 00102368 / 00102087
 Liersysteem voor voer- en drinklijnen; manueel en gemotoriseerd
 Winching system for feed- and drink lines; manual and motorised
 Nummer CE-label/number CE-label : _____

Waarop deze verklaring betrekking heeft, in overeenstemming is met:

- de volgende richtlijnen: 2006/42/EG (Machinerichtlijn); 2014/30/EU (Elektromagnetische Compatibiliteit);
- de geharmoniseerde Europese Normen: EN ISO 12100:2010; EN ISO 13854:2019; EN ISO 13857:2019; gemotoriseerd: EN IEC 60204-1:2018; EN IEC 61439-1:2021; EN IEC 61439-2:2021.

De EG-verklaring van overeenstemming / inbouwverklaring betreft uitsluitend de machine of niet voltooide machine in de toestand waarin zij op de markt is gebracht, met uitsluiting van de later door bijvoorbeeld de verdeler en/of installateur en/of eindgebruiker toegevoegde componenten en/of verrichte bewerkingen.

(NL)

Relating to this declaration is in accordance with

- The following directives 2006/42/EC (Machinery Directive); 2014/30/EU (Electromagnetic Compatibility).
- The harmonised European standards: EN ISO 12100:2010; EN ISO 13854:2019; EN ISO 13857:2019; motorised: EN IEC 60204-1:2018; EN IEC 61439-1:2021; EN IEC 61439-2:2021.

The EC-declaration of conformity / declaration of incorporation relates exclusively to the machinery or partly completed machine in the state in which it was placed on the market and excludes components which are added and/or operations carried out thereafter for instance by the distributor and/or the installer and/or the final user.

(EN)

Plaats, Datum / Place, Date: Maldegem, 01/01/2023

.....
 Dhr. Gino Van Landuyt
 Managing Director



UK Declaration of Conformity

Supply of Machinery (Safety) Regulations 2008

Manufacturer:

Roxell BV, Industrielaan 13, 9990 Maldegem

Tel: +32 50 72 91 72

Fax: +32 50 71 67 21

Declares on its own responsibility that the product:

Winching system Nr: 00102368 / 00102087

Winching system for feed- and drink lines; manual and motorised

Number UKCA-marking: _____

Relating to this declaration is in accordance with the essential requirements of

- The following Statutory Instruments:
 - o Supply of Machinery (Safety) Regulations 2008
 - o Electromagnetic Compatibility Regulations 2016
- The following Designated standards:

BS EN ISO 12100:2010; BS EN ISO 13854:2019; BS EN ISO 13857:2019; BS EN IEC 60204-1:2018; BS EN IEC 61439-1:2021; BS EN IEC 61439-2:2021.

The UK Declaration of Conformity / Declaration of Incorporation relates exclusively to the machinery or partly completed machine in the state in which it was placed on the market and excludes components which are added and/or operations carried out thereafter for instance by the distributor and/or the installer and/or the end user.

Place, Date: Maldegem, 01/01/2023

.....
Dhr. Gino Van Landuyt
Managing Director



ROXELL BV - Industrielaan 13, 9990 Maldegem (Belgium)
Tel. +32 50 72 91 72 - info@roxell.com - www.roxell.com

ROXELL USA Inc. - 720 Industrial Park Road, Anderson MO 64831 (USA)
Tel. +1 417 845 6065 - info.usa@roxell.com - www.roxell.com

ROXELL Malaysia - No. 49, Jalan Permata 2/KS9, Taman Perindustrian Air Hitam, 41200 Klang, Selangor (Malaysia)
Tel. +60 3 3123 1767 - info.malaysia@roxell.com - www.roxell.com

ROXELL Россия - ООО «Рокселл» ОГРН 1157746055026
123060, Россия, город Москва, улица Маршала Рыбалко, дом 2, корпус 9, офис 909.1
Телефон: +7 495 983 30 15 - Адрес электронной почты: info.russia@roxell.com - www.roxell.com