

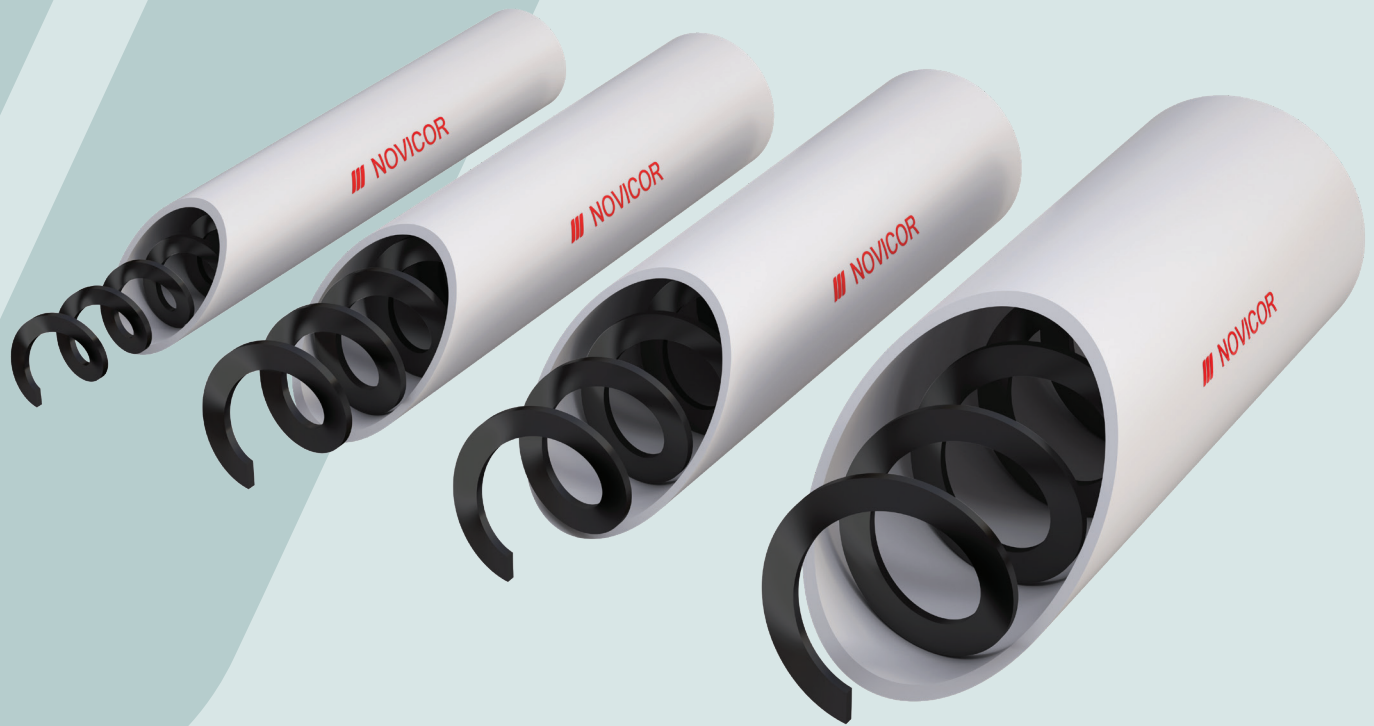

Flex-Auger™

User Guide



Original User Guide

TABLE OF CONTENTS

GENERAL INFORMATION	1
1. OBEY THE LEGAL REGULATIONS AND THE APPLICABLE RULES!	1
2. INTENDED USE	1
3. NOT-INTENDED USE	1
4. LIABILITY	1
5. PERSONNEL QUALIFICATIONS	1
6. INFORMATION ABOUT THE RESIDUAL RISKS - USED SAFETY SIGNS	1
7. DISMANTLING, STORAGE, TRANSPORT	2
8. THE LEVEL OF NOISE EMISSION	2
9. MAIN SWITCH	2
10. PROTECTION	2
GENERAL SAFETY RULES	3
OPERATOR'S GUIDE - MAINTENANCE INSTRUCTIONS	4/5
TROUBLE SHOOTING GUIDE	6
DECLARATION OF INCORPORATION OF PARTLY COMPLETED MACHINERY	
EC-DECLARATION OF CONFORMITY	

Disclaimer

The original, authoritative version of this manual is the English version produced by ROXELL BV. Subsequent changes to any manual made by any third party have not been reviewed nor authenticated by Roxell. Such changes may include, but are not limited to, translation into languages other than English, and additions to or deletions from the original content. Roxell disclaims responsibility for any and all damages, injuries, warranty claims and/or any other claims associated with such changes, in as much as such changes result in content that is different from the authoritative Roxell-published English version of the manual. For current product installation and operation information, please contact the customer service and/or technical service departments of Roxell. Should you observe any questionable content in any manual, please notify Roxell immediately in writing to: ROXELL BV - Industrielaan 13, 9990 Maldegem - Belgium.

General information

! **IMPORTANT:** These instructions must be read, understood and all points observed by the user, the responsible and operating personnel.

Obey the legal regulations and the applicable rules

This concerns, among other things, the European regulations and directives transposed into national legislation and/or the laws, safety and accident prevention regulations that apply in the user's country.

During assembly, operation and maintenance of the installation the legal regulations concerned and the applicable technical rules must be obeyed.

Intended use

The installation has been designed solely for intensive livestock use and has been developed according to the applicable rules of good workmanship. Extra loading of the product is therefore prohibited. Any other use is considered to be improper use. The manufacturer is not responsible for damage resulting therefrom. The user bears sole responsibility. The manufacturer can determine from the system data whether the product was used in accordance with the specified use.

Not-intended use

All use different than described in [Intended Use](#) is at the responsibility of the end user.

Liability

The (extended) warranty will not apply if any of the following has occurred: failure by the customer to inspect the delivered goods and report visible defects within 8 days of delivery with respect to the products, improper handling, transportation, modification or repair; accidents, defective or improper use; improper or defective assembly, installation, connection or maintenance (having regard to Roxell's most current assembly, installation, connection and maintenance manuals); improper modifications or manipulations of the operating system, hardware or any other software of the product by the customer; force majeure; negligence, lack of supervision or of maintenance on the part of customer; normal wear and tear; use of cleansing agents and disinfectants that are excluded in Roxell's most current use and maintenance manuals; use of cleansing agents and disinfectants in violation with the instructions received from the suppliers; or use of the products in an ATEX- surrounding.

The (extended) warranty shall not apply in the event of a defect caused either by materials or accessories supplied by or services rendered by the customer; or by an intervention by a person or entity which is not authorized or qualified for carrying out such intervention. Furthermore, the (extended) warranty will only apply if the products are used in livestock houses and if all parts or components of the products are supplied by Roxell.

Roxell will not be liable for any damages caused due to improper or defective use, assembly, installation, connection or maintenance of the products. In this respect, the customer expressly acknowledges that (i) all use, assembly, installation, connection or maintenance must be done in accordance with Roxell's most current assembly, installation, connection and maintenance manuals and (ii) the electrical installation on which the products must be connected must be done in accordance with applicable local legislation on electrical installations. Furthermore, the products must be tested both mechanically and electrically by the customer in accordance with state of the art techniques and applicable local legislation.

Personnel qualifications

User

The person who uses a function or operation of a product for their work or who works on the product. The user must be able to read the instructions for use and fully understand them. The user has knowledge of the functioning and construction of the installation.

Technically trained person

An expert who can assemble and maintain the installation (**mechanically/electrically**), and resolve malfunctions. On the basis of his/her technical training and experience, he/she has sufficient knowledge to be able to assess activities, recognize possible dangers and rectify dangerous situations.

Storage

Put all parts to be assembled in a room or at a location where the not yet assembled components are protected against weather influences.

Transport

Depending on the size of the parts and according to local circumstances and local legislation, the parts of the machine have to be transported with a forklift.

The forklift must be operated by a qualified person and in accordance with the rules of good workmanship. When lifting the load, always check if the center of gravity of the load is stable.

Dismantling

Dismantle the installation and its components in accordance with the environmental legislation of the country or the local authorities applicable at that time. All functioning products and exchange parts must be stored and disposed of in accordance with the applicable environmental regulations.

Environmental information for customers in the European Union

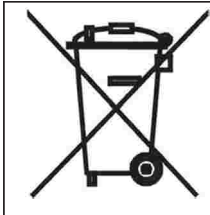

The European legislation requires that equipment marked with this symbol on the product or packaging must not be collected with unsorted household waste. This symbol indicates that the waste electrical and electronic equipment (WEEE) cannot be disposed of in the regular household waste. We highly recommend that you bring your product to an official collection point so that an expert can remove the waste electrical and electronic equipment. Inform yourself of local legislation on separate collection of waste electrical and electronic equipment. Respect the local regulations and never dispose of the product together with household waste.

Information about waste disposal - electrical/electronic material for companies

1. In the European Union

If you have used the product for commercial purposes and you want to dispose of it, contact Roxell, who will give you information about the return of the product. It is possible that you will have to pay a disposal charge for the return and recycling. Small products (and small quantities) can be processed by the local collection agencies.

2. In other countries outside the European Union

If you want to dispose of this product, contact the local authorities for information concerning the correct disposal procedure.

The level of noise emission

The noise level of the installation in operation does not exceed 70 dB(A).

LOTOTO = Lock Out - Tag Out - Try Out

Before you begin: Everyone needs his own lock and tag (label), which can't be removed by other persons. Inform all the persons who are influenced by the procedure.

1 To block

- Localize all sources of energy (electric, hydraulic, pneumatic).
- Switch off.
- Take the relevant installation or process out of operation and lock it against reuse. You can do this by placing a padlock or other blocking mechanism (Lock Out).

2 To mark

Attach a sign, label or sticker to the padlock or blocking mechanism to reveal the nature and the expected duration of the work to other persons (Tag Out).

3 To check

- Check if the source of energy is switched off.
- Remove any remaining energy.
- Check that the installation or process is actually safe (Try Out).

Use personal protective equipment

Ensure you wear personal protective equipment (gloves, dust masks...).

Illuminance - sufficient lighting

- **A minimum illuminance of 200 lux is necessary** during usage, maintenance and installation.
- Provide at the installation **(portable) emergency lighting in case of power failure**.

Electrical equipment, control panels, components and drive units







- To operate control panels, there must be **at least 70 cm of free space**.
- Control panels must **always remain closed**. The key of the control panel must be in possession of an authorized person. Only an electrically trained person (see above) shall carry out maintenance activities inside the control panels.
- The necessary measures must be taken by the user to keep out **rats, mice and other vermin from the control panels**.
- If electrical equipment, control panels, components and drive units are damaged, the system must be stopped **immediately!**
- Electrical equipment, control panels, components and drive units should **never be sprayed with water or other liquid!**
- Electrical equipment, control panels, components and drive units should **never be covered with any material**.

Information about the residual risks - used safety signs

There are three levels of danger, which you can recognize from the following signal words:

- **DANGER**
- **WARNING**
- **CAUTION**

The nature and source of the imminent danger and possible consequences of not obeying warnings is stated here!

Symbol	Meaning
	DANGER indicates a direct imminent danger that can result in a serious or even fatal accident if the safety measures are not respected.
	WARNING indicates a possible imminent danger that can result in a serious accident or damage to the product if the safety measures are not respected.
	CAUTION indicates possible, dangerous situations that can result in minor physical injury or material damage if the safety measures are not respected.
	This symbol refers to supporting information.
	Allowed
	Not allowed
	This symbol will be used to draw your attention to matters that are of great importance for your safety. It means: warning - follow the safety instructions. Disconnect the current and read the safety rules. In short: be alert. Ignoring these instructions can cause serious injuries or even death.

GENERAL SAFETY RULES

Flex Auger Nr. : 031...

Transportsysteem voor droogvoeder van dieren

Transport system of dry feed for animals



DANGER

IMPORTANT

Carefully read the following instructions before
USING the system

1. Before you do any **repair**, or **maintenance works**, always **disconnect the electricity supply by means of the main switch**.
2. Ensure you wear **personal protection equipment** (gloves, dust masks).
3. The system **starts automatically**.
Never use your **hands** at **dangerous locations** (feed intake boots, drive units, control units or outlet holes in the tubes) before you have **completely switched off** the transport system and made sure that **nobody** can **switch it on** without your knowledge.
4. Take care that neither strangers nor children can **open the bin boot**.
5. **Never** allow **unauthorized persons** to **enter the house** in your absence.
6. If the auger stalls : **immediately** switch **off** the system. Carefully read the trouble shooting guide and strictly follow instructions. Contact a **technically trained person**.
An auger **under tension** can **cause very serious injuries** when released.
7. Regularly check the **elbow/trough and/or tube connections**. Tighten if necessary.
8. Ensure that the **hopper cover (grill) or cover** on the 100 kg hopper **closes properly**.
9. Regularly check that the **control unit** and/or the **motor handy box** are properly closed.



This **SYMBOL** will be used to draw your attention to matters that are of **GREAT IMPORTANCE** for your **SAFETY**.

It means : **WARNING** - follow the safety instructions :
disconnect the current - re-read the safety rules.

In short : **BE ALERT**. **IGNORING** these instructions can cause
SERIOUS INJURIES or even **DEATH**.

OPERATOR'S GUIDE

ACTIONS IN GREY BACKGROUND MUST BE DONE BY A TECHNICALLY TRAINED PERSON.

1. **Never let the Flex-Auger run without feed. When the Flex-Auger runs empty, the life time of the system is reduced considerably.**
2. Open the slide valve under the bin completely when the system runs with mash or pellets. Always use a thumper when feeding mash. Always use pellet guides when feeding pellets (close the flow regulator).
3. **THE LEVEL SWITCH IS INSTALLED LOW INSIDE THE LAST FEEDING TROUGH OR HOPPER.**
See that there are enough animals in the last pen : they empty the trough completely, so that fresh feed will be supplied at all times.
4. The restrictor on the boot anchor adjusts the amount of feed taken away by the auger. Start any new system with the restrictor in minimum position. Let the system run a while before you adjust the feed flow, allowing the auger to be cleaned by the feed. You obtain minimum feed flow by moving the restrictor as far as possible away from the anchor. In a Flex-Auger system with **EXTENSION BOOT**, the second part must convey more feed than the first part.

Adjust the restrictor in the intake boot with restrictor (beneath the weigher, daybin, bin....) if necessary.
5. If the Flex-Auger starts from a tandem system : empty one bin after another. **Never** feed from both bins at the same time. When one of the bins is empty, remove the thumper (if used).
6. **Maximum running time per day : 4 hours** (system without elbows) / **2 hours** (system with elbows). For layer feed and any feed other than commercial feed or poultry and pigs, the maximum running times are considerably shorter !

7. Use of the slide valve :

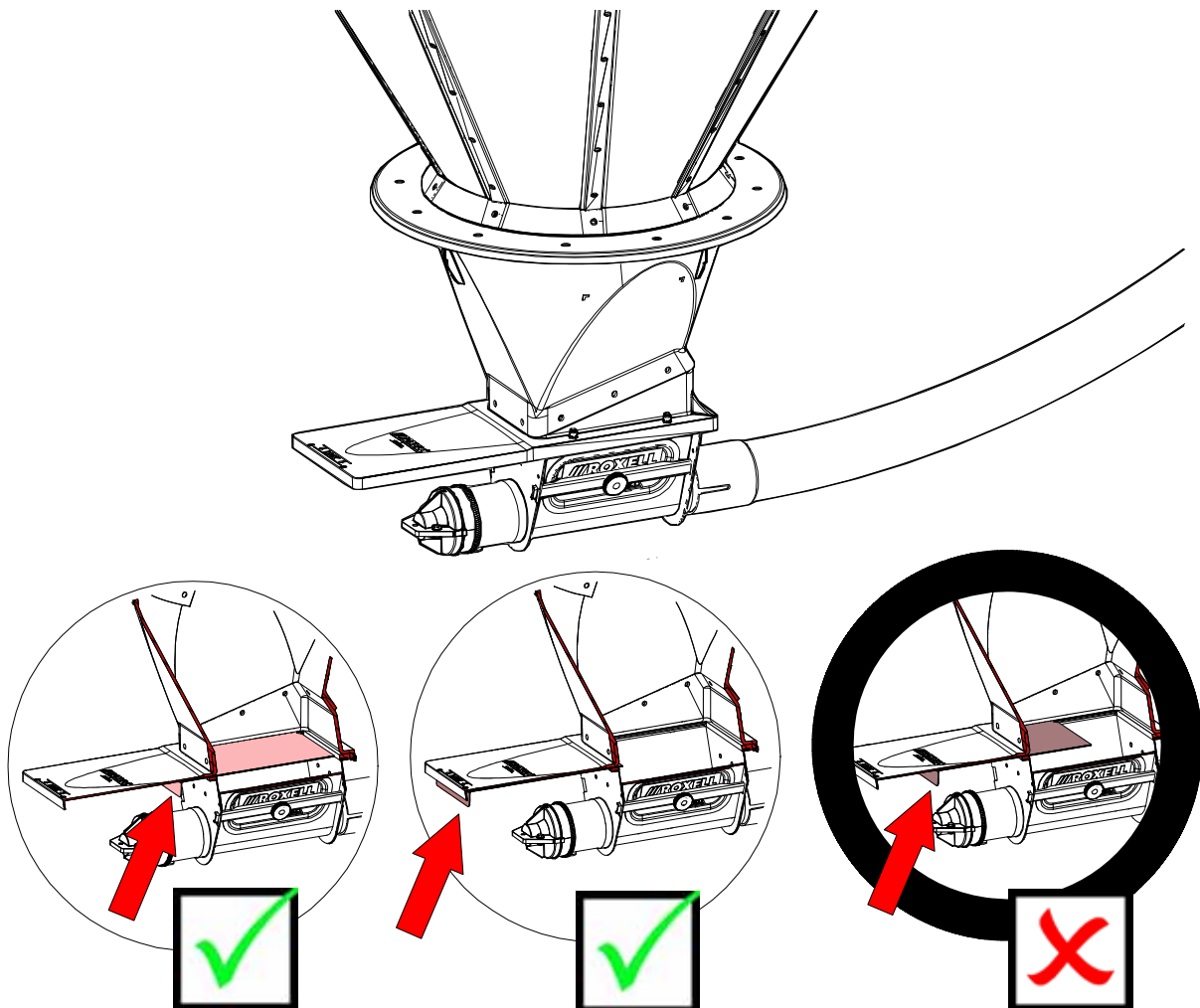

ATTENTION : Contact ROXELL your supplier for professional advice when using following feeds :

 CCM (Corn Cob Mix) - Feed mixed with CCM - Soya - Soya lumps - Wet feed.

 Without explicit authorization, all our warranties will expire and no claims will be accepted.

Also contact Roxell if you want to use strongly grating feeds like hen feed etc...

MAINTENANCE INSTRUCTIONS				
 DANGER	Switch off the main switch first. Use personal protective equipment.	3-monthly	6-monthly	Yearly
		ACTIONS IN GREY BACKGROUND MUST BE DONE BY A TECHNICALLY TRAINED PERSON.		
1. Power unit				
- Make fan dust-free				X
- Check possible damages to electrical wiring				X
2. Suspension				
- Check suspension of tubes and motors		X		
3. Sensors/switches				
- Check operation of safety switch			X	
- Check electrical wiring				X
4. Lines				
- Check screws and bolts in the system after the first month and after each batch. Tighten if necessary.		X		
- Keep tubes level.		X		
- Remove all feed from the system when the system will be out of use for a period.				

TROUBLE SHOOTING GUIDE



DANGER

**Switch off the main switch first.
Use personal protective equipment.**

ACTIONS IN GREY BACKGROUND MUST BE DONE BY A TECHNICALLY TRAINED PERSON.

PROBLEM	CAUSE	CORRECTIVE ACTION
1. Transport system does not run.	No supply voltage.	Check fuses and/or reset circuit breakers. Check cut-off-switches and current lead to the house. Repair if necessary.
	Defective level switch.	Check correct installation of the level switch. Find cause of possible feed bridging in control unit. Check level switch and replace if necessary.
	Defective safety switch in control unit.	Check operation of safety switch. Replace if necessary.
	Defective motor.	Replace motor.
2. Motor overloads after running for a short while.	Wrong motor.	Check motor power. Replace motor if necessary.
	Voltage too low (motor runs too slowly and overheats).	Check current supply to motor. Use wires with correct diameter for the connection.
	Foreign object in auger. Motor runs, then stalls.	ATTENTION ! Disconnect the auger carefully and pull it out of the tubes. Remove the object. Clean auger and tubes. Check fat content, percentage of moisture etc... of the feed.
	Motor runs in reverse (runs, then stalls : no feed is conveyed).	Disconnect power. Change wires. Motor shaft on the back of the motor must turn clockwise. Check the auger for damages.
	Motor overheats.	Replace motor.
NOTE : NEVER SET THERMAL-MAGNETIC PROTECTION HIGHER THAN THE VALUE MENTIONED ON THE MOTOR LABEL !		
3. Motor runs, but auger does not turn.	Broken bolt or worn-out set screw in drive shaft.	Replace bolt or set screw.
4. Auger wears holes in straight tubes.	Auger kinked or poorly brazed.	See instructions.
5. Elbows wear out.	Auger too short or too long.	Adjust auger length. Install an extension boot if necessary.
6. Auger runs erratically.	Boot bearing jammed or worn out.	Replace bearing.
	Auger too long.	Shorten auger. Close all outlets. Remove bearing and anchor. Disconnect auger. Let system run for a short while. Cut auger at rear end of boot. Reinstall.
	Poor suspension of the tubes or too many elbows.	Provide more suspension points. Adjust height. Decrease number of elbows.
	Kinked and/or poorly brazed auger scrapes along the tubes.	See auger brazing.
7. Transport system short cycles continually.	- Level switch not installed on the right spot in 100kg hopper.	- Adjust level switch position.
	- Sensor in tube.	- Use a sensor VC11 or VC12 if necessary.
8. Feed bridging in extension boot.	Not enough feed drop from last outlet before the extension boot.	Provide 100 % feed drop.
	Time set too short on relay.	See instructions.
9. Second part (past the extension boot) does not start.	Defective level switch on first part.	Check operation of level switch. Replace if necessary.



Inbouwverklaring betreffende niet voltooide machines (Richtlijn 2006/42/EG, Bijlage II.1.B)
Declaration of incorporation of partly completed machinery (Directive 2006/42/EC, Annex II.1.B)

Fabrikant/Manufacturer:
Roxell BV, Industrielaan 13, 9990 Maldegem
Tel: +32 50 72 91 72
Fax: +32 50 71 67 21

Verklaart geheel onder eigen verantwoordelijkheid dat het product:
Declares on its own responsibility that the product:

Flex-Auger Nr: 031...
Transportsysteem voor droogvoeder van dieren.
Transport system of dry feed for animals.

Waarop deze verklaring betrekking heeft, in overeenstemming is met:

- de volgende richtlijnen: 2006/42/EG (Machinerichtlijn); 2014/30/EU (Elektromagnetische Compatibiliteit);
- de geharmoniseerde Europese Normen: EN ISO 12100:2010; EN ISO 13854:2019; EN ISO 13857:2019; EN IEC 60204-1:2018; EN IEC 61439-1:2021; EN IEC 61439-2:2021.

Het is verboden bovengenoemd product in gebruik te stellen voordat de machine waarin het wordt ingebouwd in overeenstemming met de bepalingen van de Machinerichtlijn is verklaard.

Tevens verbindt de fabrikant (of zijn gemachtigde) zich om op met redenen omkleed verzoek van de nationale autoriteiten de relevante informatie over deze niet voltooide machine door te geven. De wijze van doorgifte is digitaal. De wijze van informatievervalsing laat de intellectueel-eigendomsrechten van de fabrikant van de niet voltooide machine onverlet

(NL)

Relating to this declaration is in accordance with

- The following directives 2006/42/EC (Machinery Directive); 2014/30/EU (Electromagnetic Compatibility).
- The harmonised European standards: EN ISO 12100:2010; EN ISO 13854:2019; EN ISO 13857:2019; EN IEC 60204-1:2018; EN IEC 61439-1:2021; EN IEC 61439-2:2021.

This product must not be put into service until the machinery into which it is to be incorporated has been declared in conformity with the provisions of the Machinery Directive.

The manufacturer (or its agent) also undertakes, at the duly reasoned request of the national authorities, to provide the relevant information concerning this partly completed machinery. The method of transmission will be digital. The manner in which the information is provided does not prejudice the manufacturer's intellectual property rights concerning the partly completed machinery.

(EN)

03000601

Plaats, Datum / Place, Date: Maldegem, 01/01/2023

.....
Dhr. Gino Van Landuyt
Managing Director

"This part may only be filled out if all built-in subparts are delivered by Roxell"

EG-verklaring van overeenstemming (Richtlijn 2006/42/EG, Bijlage II.1.A)
EC-declaration of conformity (Directive 2006/42/EC, Annex II.1.A)

Wij/We _____
(naam installateur/name fitter)

(volledig adres en land/complete address)

Verklaren geheel onder eigen verantwoording de
Declare completely on own justification that

(naam machine/name machinery) (nummer CE-label/number CE-label)

In een installatie te hebben ingebouwd geheel volgens de Roxell-voorschriften en in overeenstemming met de bepalingen van de Machinerichtlijn.
Has been incorporated in conformity with the provisions of the Machinery Directive and the prescriptions of Roxell BV.

(plaats, datum/place, date) (naam, handtekening/name, signature)

De EG-verklaring van overeenstemming / inbouwverklaring betreft uitsluitend de machine of niet voltooide machine in de toestand waarin zij op de markt is gebracht, met uitsluiting van de later bijvoorbeeld door de verdeler en/of installateur en/of eindgebruiker toegevoegde componenten en/of verrichte bewerkingen.

The EC-declaration of conformity / declaration of incorporation relates exclusively to the machinery or partly completed machine in the state in which it was placed on the market and excludes components which are added and/or operations carried out thereafter for instance by the distributor and/or the installer and/or the final user.



UK Declaration of Incorporation of partly completed machinery
Supply of Machinery (Safety) Regulations 2008

Manufacturer:
Roxell BV, Industrielaan 13, 9990 Maldegem
Tel: +32 50 72 91 72
Fax: +32 50 71 67 21

Declares on its own responsibility that the product:

Flex-Auger No 031.....
Transport system of dry feed for animals.

Relating to this declaration is in accordance with the essential requirements of

- The following Statutory Instruments:
 - o Supply of Machinery (Safety) Regulations 2008
 - o Electromagnetic Compatibility Regulations 2016
- The following Designated standards:

BS EN ISO 12100:2010; BS EN ISO 13854:2019; BS EN ISO 13857:2019; BS EN IEC 60204-1:2018; BS EN IEC 61439-1:2021; BS EN IEC 61439-2:2021.

This product must not be put into service until the machinery into which it is to be incorporated has been declared in conformity with the provisions of Supply of Machinery (Safety) Regulations 2008.

The manufacturer (or its agent) also undertakes, at the duly reasoned request of the national authorities, to provide the relevant information concerning this partly completed machinery. The method of transmission will be digital. The manner in which the information is provided does not prejudice the manufacturer's intellectual property rights concerning the partly completed machinery.

Place, Date: Maldegem, 01/01/2023

.....
Dhr. Gino Van Landuyt
Managing Director

"This part may only be filled out if all built-in subparts are delivered by Roxell"

UK Declaration of Conformity
Supply of Machinery (Safety) Regulations 2008

We _____
(name installer)

(complete address)

declare completely on own justification that

(name machinery) (number UKCA-marking)

has been incorporated in conformity with the provisions Supply of Machinery (Safety) Regulations 2008 and the prescriptions of Roxell BV.

(place, date) (name, signature)

The UK Declaration of Conformity / Declaration of Incorporation relates exclusively to the machinery or partly completed machine in the state in which it was placed on the market and excludes components which are added and/or operations carried out thereafter for instance by the distributor and/or the installer and/or the end user.



ROXELL BV - Industrielaan 13, 9990 Maldegem (Belgium)
Tel. +32 50 72 91 72 - info@roxell.com - www.roxell.com

ROXELL USA Inc. - 720 Industrial Park Road, Anderson MO 64831 (USA)
Tel. +1 417 845 6065 - info.usa@roxell.com - www.roxell.com

ROXELL Malaysia - No. 49, Jalan Permata 2/KS9, Taman Perindustrian Air Hitam, 41200 Klang, Selangor (Malaysia)
Tel. +60 3 3123 1767 - info.malaysia@roxell.com - www.roxell.com

ROXELL Россия - ООО «Рокселл» ОГРН 1157746055026
123060, Россия, город Москва, улица Маршала Рыбалко, дом 2, корпус 9, офис 909.1
Телефон: +7 495 983 30 15 - Адрес электронной почты: info.russia@roxell.com - www.roxell.com