



# Boozzter™

## User Guide



Original User Guide

# TABLE OF CONTENTS

DISCLAIMER

GENERAL INFORMATION

GENERAL SAFETY RULES .....	5
HOUSE CHART .....	6
CLEANING .....	7
CLEANING AND DESINFECTING (NATURAL BEAK SMOOTHING) .....	8
MAINTENANCE INSTRUCTIONS .....	9
TROUBLE SHOOTING GUIDE .....	10
DAILY WINCHING - GENERAL SAFETY RULES .....	12
DAILY WINCHING - TROUBLE SHOOTING GUIDE .....	13
DAILY WINCHING - MAINTENANCE INSTRUCTIONS .....	13

DECLARATION OF INCORPORATION OF PARTLY COMPLETED MACHINERY

EC-DECLARATION OF CONFORMITY

## Disclaimer

The original, authoritative version of this manual is the English version produced by ROXELL BV. Subsequent changes to any manual made by any third party have not been reviewed nor authenticated by Roxell. Such changes may include, but are not limited to, translation into languages other than English, and additions to or deletions from the original content. Roxell disclaims responsibility for any and all damages, injuries, warranty claims and/or any other claims associated with such changes, in as much as such changes result in content that is different from the authoritative Roxell-published English version of the manual. For current product installation and operation information, please contact the customer service and/or technical service departments of Roxell. Should you observe any questionable content in any manual, please notify Roxell immediately in writing to: ROXELL BV - Industrielaan 13, 9990 Maldegem - Belgium.



# General information

**!** **IMPORTANT:** These instructions must be read, understood and all points observed by the user, the responsible and operating personnel.

## Obey the legal regulations and the applicable rules

This concerns, among other things, the European regulations and directives transposed into national legislation and/or the laws, safety and accident prevention regulations that apply in the user's country.

During assembly, operation and maintenance of the installation the legal regulations concerned and the applicable technical rules must be obeyed.

## Intended use

The installation has been designed solely for intensive livestock use and has been developed according to the applicable rules of good workmanship. Extra loading of the product is therefore prohibited. Any other use is considered to be improper use. The manufacturer is not responsible for damage resulting therefrom. The user bears sole responsibility. The manufacturer can determine from the system data whether the product was used in accordance with the specified use.

## Not-intended use

All use different than described in [Intended Use](#) is at the responsibility of the end user.

## Liability

The (extended) warranty will not apply if any of the following has occurred: failure by the customer to inspect the delivered goods and report visible defects within 8 days of delivery with respect to the products, improper handling, transportation, modification or repair; accidents, defective or improper use; improper or defective assembly, installation, connection or maintenance (having regard to Roxell's most current assembly, installation, connection and maintenance manuals); improper modifications or manipulations of the operating system, hardware or any other software of the product by the customer; force majeure; negligence, lack of supervision or of maintenance on the part of customer; normal wear and tear; use of cleansing agents and disinfectants that are excluded in Roxell's most current use and maintenance manuals; use of cleansing agents and disinfectants in violation with the instructions received from the suppliers; or use of the products in an ATEX- surrounding.

The (extended) warranty shall not apply in the event of a defect caused either by materials or accessories supplied by or services rendered by the customer; or by an intervention by a person or entity which is not authorized or qualified for carrying out such intervention. Furthermore, the (extended) warranty will only apply if the products are used in livestock houses and if all parts or components of the products are supplied by Roxell.

Roxell will not be liable for any damages caused due to improper or defective use, assembly, installation, connection or maintenance of the products. In this respect, the customer expressly acknowledges that (i) all use, assembly, installation, connection or maintenance must be done in accordance with Roxell's most current assembly, installation, connection and maintenance manuals and (ii) the electrical installation on which the products must be connected must be done in accordance with applicable local legislation on electrical installations. Furthermore, the products must be tested both mechanically and electrically by the customer in accordance with state of the art techniques and applicable local legislation.

## Personnel qualifications

### User

The person who uses a function or operation of a product for their work or who works on the product. The user must be able to read the instructions for use and fully understand them. The user has knowledge of the functioning and construction of the installation.

## Technically trained person

An expert who can assemble and maintain the installation (**mechanically/electrically**), and resolve malfunctions. On the basis of his/her technical training and experience, he/she has sufficient knowledge to be able to assess activities, recognize possible dangers and rectify dangerous situations.

## Storage

Put all parts to be assembled in a room or at a location where the not yet assembled components are protected against weather influences.

## Transport

Depending on the size of the parts and according to local circumstances and local legislation, the parts of the machine have to be transported with a forklift.

The forklift must be operated by a qualified person and in accordance with the rules of good workmanship. When lifting the load, always check if the center of gravity of the load is stable.

## Dismantling

Dismantle the installation and its components in accordance with the environmental legislation of the country or the local authorities applicable at that time. All functioning products and exchange parts must be stored and disposed of in accordance with the applicable environmental regulations.

## Environmental information for customers in the European Union

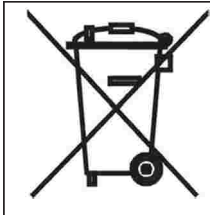

The European legislation requires that equipment marked with this symbol on the product or packaging must not be collected with unsorted household waste. This symbol indicates that the waste electrical and electronic equipment (WEEE) cannot be disposed of in the regular household waste. We highly recommend that you bring your product to an official collection point so that an expert can remove the waste electrical and electronic equipment. Inform yourself of local legislation on separate collection of waste electrical and electronic equipment. Respect the local regulations and never dispose of the product together with household waste.

## Information about waste disposal - electrical/electronic material for companies

### 1. In the European Union

If you have used the product for commercial purposes and you want to dispose of it, contact Roxell, who will give you information about the return of the product. It is possible that you will have to pay a disposal charge for the return and recycling. Small products (and small quantities) can be processed by the local collection agencies.

### 2. In other countries outside the European Union

If you want to dispose of this product, contact the local authorities for information concerning the correct disposal procedure.

## The level of noise emission

The noise level of the installation in operation does not exceed 70 dB(A).

## LOTOTO = Lock Out - Tag Out - Try Out

Before you begin: Everyone needs his own lock and tag (label), which can't be removed by other persons. Inform all the persons who are influenced by the procedure.

### 1 To block

- Localize all sources of energy (electric, hydraulic, pneumatic).
- Switch off.
- Take the relevant installation or process out of operation and lock it against reuse. You can do this by placing a padlock or other blocking mechanism (Lock Out).

### 2 To mark

Attach a sign, label or sticker to the padlock or blocking mechanism to reveal the nature and the expected duration of the work to other persons (Tag Out).

### 3 To check

- Check if the source of energy is switched off.
- Remove any remaining energy.
- Check that the installation or process is actually safe (Try Out).

## Use personal protective equipment

Ensure you wear personal protective equipment (gloves, dust masks...).

## Illuminance - sufficient lighting

- **A minimum illuminance of 200 lux is necessary** during usage, maintenance and installation.
- Provide at the installation **(portable) emergency lighting in case of power failure.**

## Electrical equipment, control panels, components and drive units







- To operate control panels, there must be **at least 70 cm of free space.**
- Control panels must **always remain closed.** The key of the control panel must be in possession of an authorized person. Only an electrically trained person (see above) shall carry out maintenance activities inside the control panels.
- The necessary measures must be taken by the user to keep out **rats, mice and other vermin from the control panels.**
- If electrical equipment, control panels, components and drive units are damaged, the system must be stopped **immediately!**
- Electrical equipment, control panels, components and drive units should **never be sprayed with water or other liquid!**
- Electrical equipment, control panels, components and drive units should **never be covered with any material.**

## Information about the residual risks - used safety signs

There are three levels of danger, which you can recognize from the following signal words:

- **DANGER**
- **WARNING**
- **CAUTION**

The nature and source of the imminent danger and possible consequences of not obeying warnings is stated here!

Symbol	Meaning
	<b>DANGER</b> indicates a direct imminent danger that can result in a serious or even fatal accident if the safety measures are not respected.
	<b>WARNING</b> indicates a possible imminent danger that can result in a serious accident or damage to the product if the safety measures are not respected.
	<b>CAUTION</b> indicates possible, dangerous situations that can result in minor physical injury or material damage if the safety measures are not respected.
	This symbol refers to supporting information.
	Allowed
	Not allowed
	This symbol will be used to draw your attention to matters that are of great importance for your safety. <b>It means: warning - follow the safety instructions. Disconnect the current and read the safety rules. In short: be alert. Ignoring these instructions can cause serious injuries or even death.</b>

## GENERAL SAFETY RULES

KiXoo/Vitoo/Boozzter Nr: 008.../008.../002...

Automatisch pannen voedersysteem voor opfok en productie van slachtkuikenouderdieren.

Automatic pan feeding system for rearing and production of broiler breeders.

Winching systeem

Liersysteem voor voer- en drinklijnen

Winching system for feed and drink lines



**DANGER**

## IMPORTANT

**Carefully read the following instructions before USING the system**

1. Before you do any **repair**, or **maintenance works**, always **disconnect the electricity supply**.
2. Ensure you wear **personal protection equipment** (gloves, dust masks).
3. The system **starts automatically**.  
**Never** use your **hands** at **dangerous locations** (feed intake boots, drive units, control units or outlet holes in the tubes) before you have **completely switched off** the transport system and made sure that **nobody** can **switch it on** without your knowledge.
4. **Never** allow **unauthorized persons** to **enter the house** in your absence.
5. **Be careful** when **lowering** or **winching** up the feeding lines/circuits :
  - **stop** immediately at the slightest hitch.
  - **never** stay **underneath** when lowering or winching up the lines/circuit.
6. If the auger stalls : **immediately** switch **off** the system. Carefully read the trouble shooting guide and strictly follow instructions. Contact a **technically trained person**.  
An auger **under tension** can **cause very serious injuries** when released.
7. Regularly check the **elbow/trough and/or tube connections**. Tighten if necessary.
8. Regularly check that the **control unit (pan)** and/or the **motor handy box** are properly closed.
9. Ensure that the **hopper cover grill or cover** on the 100 kg hopper **closes properly**.
10. The standard winching system is **only suitable for height regulation** during the flock's stay and **winching up for cleaning** (1x per flock). For more frequent winching, use the **daily winching components**.



This **SYMBOL** will be used to draw your attention to matters that are of **GREAT IMPORTANCE** for your **SAFETY**.

It means : **WARNING** - follow the safety instructions : disconnect the current - re-read the safety rules.

In short : **BE ALERT**. **IGNORING** these instructions can cause **SERIOUS INJURIES** or even **DEATH**.



### 6 WAYS TO GET A BETTER UNIFORMITY :

- 1 Keep the number of birds/pan constant (10 animals/pan).  
Use the shut-off-shell when removing pans from the system (< 10 animals/pan = remove pans).
- 2 Keep the pans at the correct height : allow all the cockerels to eat .
- 3 Keep the litter in good shape and level and remove superfluous/dirty litter.
- 4 Take care that all the lines are suspended perfectly level.
- 5 Adjust the eating speed by turning the adjuster ring. An eating time of 25 till 45 minutes is recommended.  
The most common position of the adjuster ring is between 6 and 12.
- 6 Only start to feed the cockerels when all the females have access to their feed.

Keep the Boozzter pans slightly higher than the back of the males. →

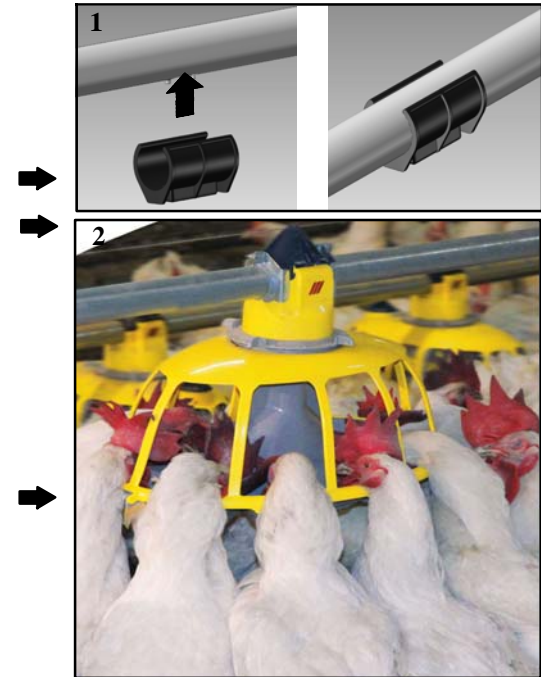

#### Poultry perch system



- do not use it constantly
- use as WARNING !

### CLEANING

- \* The last day : run the tubes empty and let the birds empty the pans as much as possible.
- \* Collect the feed residues by opening all pans, and empty them.
- \* Protect electrical components against water.
- \* Clean the whole system by means of a high-pressure cleaner (max. 100 Bar).
- \* When using aggressive detergents or disinfectants consult your supplier.

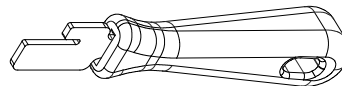

09701863 OPENING TOOL BOOZZTER PAN

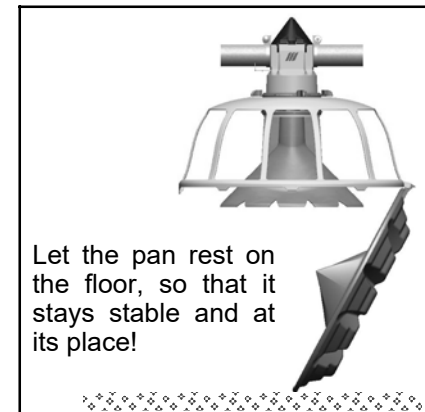

## CLEANING

- \* The last day : run the tubes empty and let the birds empty the pans as much as possible.
- \* Winch up the lines to a working height of about 1m for easy cleaning.
- \* Collect the feed residues by opening all pans, and empty them.
- \* Protect electrical components against water.
- \* Clean the whole system by means of a high-pressure cleaner (**max 100 BAR**).
- \* When using aggressive detergents or disinfectants consult your supplier.



CAUTION

**Before cleaning, release the bottom pan and turn it downwards. Ensure that the feeder pan can fully drip off and dry after cleaning to prevent corrosion of the metal insert.**

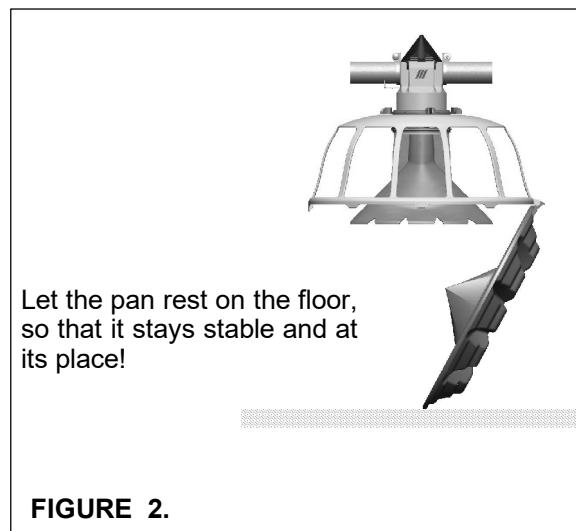
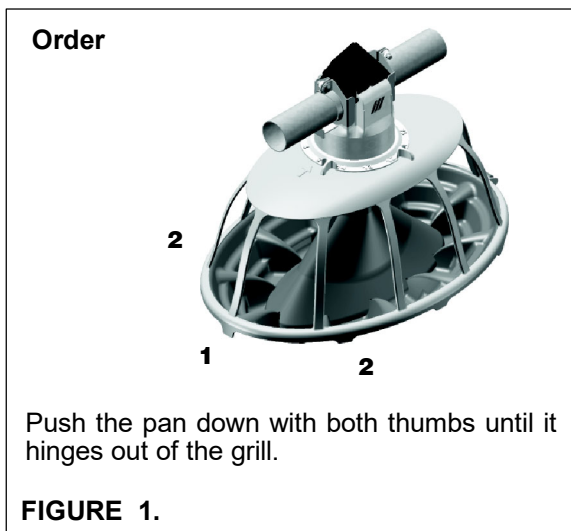

## **CLEANING AND DESINFECTING (NATURAL BEAK SMOOTHING)**

- Do not use any products that can lead to corrosion of galvanized steel.
- Always follow the prescriptions of the manufacturer of the cleaning and disinfecting agent closely. Use the prescribed concentration and contact time.
- Rinse carefully with pure water to remove all residues after cleaning and disinfecting.
- Rinse carefully between using different cleaning and disinfecting products.
- Remove all residual water from the feeding pans by letting the pans drip out after cleaning and disinfecting and dry out before closing.
- Remove all residues after drying.
- Cleaning advice:  
Clean using a mild alkaline agent (pH 8-10) e.g. pro-Rein (Cidlines) or other according to the specifications of the manufacturer (concentration and contact time).
- Disinfecting advice:  
Disinfect using an agent based on glutaraldehyde and quaternary ammonium compounds e.g. Virocid (Cidlines) or other according to the specifications of the manufacturer (concentration and contact time).



**CAUTION**

**Before cleaning, release the bottom pan and turn it downwards. Ensure that the feeder pan can fully drip off and dry after cleaning to prevent corrosion of the metal insert.**

<b>MAINTENANCE INSTRUCTIONS</b>				
 <b>DANGER</b>	<b>Switch off the main switch first. Use personal protective equipment.</b>	3-monthly	6-monthly	Yearly
<b>ACTIONS IN GREY BACKGROUND MUST BE DONE BY A TECHNICALLY TRAINED PERSON.</b>				
1. Power unit				
- Make fan dust-free			<b>X</b>	
- Check possible damages to electrical wiring				<b>X</b>
2. Drive unit (circuits)				
- Make fan dust-free			<b>X</b>	
- Check possible damages to electrical wiring				<b>X</b>
- Clean gear housing				<b>X</b>
3. 100kg hopper (lines)				
- Check level switch				<b>X</b>
4. Suspension				
- Check operation of (central) winch	<b>X</b>			
- Check operation of (central) winch. Grease after cleaning.			<b>X</b>	
- Check connection of cable	<b>X</b>			
- Check connection of pulleys	<b>X</b>			
- Check suspension of tubes and motors	<b>X</b>			
- Keep suspension cord/cable in tension	<b>X</b>			
5. Poultry perch cable above the tubes/elbows				
- Check cable				<b>X</b>
6. Pans				
- Check possible damages of pans				<b>X</b>
7. Sensors/switches				
- Check operation of safety switch or sensor.			<b>X</b>	
- Check electrical wiring				<b>X</b>
8. Feed intake boot				
- Clean				<b>X</b>
- Check possible wear of plastic gear				<b>X</b>
9. Lines/circuits				
- Check screws and bolts in the system after the <b>first month and after each batch</b> . Tighten if necessary.	<b>X</b>			
- Keep tubes level.	<b>X</b>			
- Remove all feed from the system when the system will be out of use for a period.	<b>X</b>			

## TROUBLE SHOOTING GUIDE



**Switch off the main switch first.  
Use personal protective equipment.**

**DANGER**

**ACTIONS IN GREY BACKGROUND MUST BE DONE BY A TECHNICALLY TRAINED PERSON.**

**FOR ANY AUTOMATIC OPERATION, NONE OF THE YELLOW LAMPS SHOULD BURN !**

PROBLEM	YELLOW LAMP	CAUSE	CORRECTIVE ACTION
1. None of the feeder lines run.	NO	No current.	Check main switch and/or fuses and/or line current.
2. FA bin to weigher does not run	NO	a. Operation button not on "ON" position.	Adjust button.
	NO	b. Max. switch of weigher remains activated.	Check Max. switch and repair or replace it if necessary.
		c. FA safety switch is activated.	Disengage safety switch and find cause of blockage.
	YES	d. Thermal-magnetic switch-off of the FA.	Check fuses. Check adjustment of motor protection. Reload motor protection and check its proper operation.
3. FA weigher to circuits does not run.	NO	a. See 2.a.	
		b. Sensor remains activated. See signal lamp sensor.	Check and repair.
	NO	c. See 2.b. and 2.c.	
	YES	d. See 2.d.	
4. FA weigher to circuits short cycles	NO	a. Sensor not properly installed.	Check.
		b. Timer of sensor adjusted too low.	Adjust timer on a higher value.
5. The circuit does not run.	NO	Wrong programming of time clock or counter or no programming at all.	Check programming.
	YES YES	a. Left or right hand motor of one or more circuits switched-off without being overloaded.	Check fuses. Check adjustment of motor protection. Reload motor protection and check its proper operation.
		b. Left or right hand motor of one or more circuits switched-off thermal-magnetically (overloaded).	
		1. Too much feed in the tubes.	Have pans emptied by the birds. Check the operation of the sensor in the control pan.
	2. Connector intake boot/tube or tube-elbow not properly tightened.	Tighten connector correctly.	
	3. Auger coupling not properly installed.	Check auger couplings and replace if necessary.	



PROBLEM	YELLOW LAMP	CAUSE	CORRECTIVE ACTION
		4. Auger kinked . 5. Wheel inside intake boot is blocked. 6. Obstruction in the tube.	Replace damaged auger. Disengage wheel or replace if necessary.  Find blocking spot and remove the obstruction. SEE NOTE* .



**DANGER**

**NOTE : IF THE AUGER OF THE CIRCUIT IS BLOCKED AS A RESULT OF ONE OF THE ABOVE PROBLEMS, IT WILL BE UNDER SPRING TENSION, SO BE EXTREMELY CAREFUL AND PROCEED AS DESCRIBED BELOW THIS PAGE\***

6. The circuit : - stops prematurely. - does not stop in time.		a. Time set on time clock is not sufficient.	Adjust time clock programming.
		b. The sensor in the control pan is defective or not properly adjusted.	Check the sensor operation and replace if necessary
7. Auger runs erratically.		a. When using the system for the first time.	This is not a breakdown; it will be ok after a couple of days.
		b. Auger too short.	Adjust auger length.
		c. Auger kinked as a result of careless installation.	Replace kinked parts.
		d. Auger coupling not properly installed.	See installation instructions. Replace coupling if necessary.
		e. Circuit too long.	Check maximum length and install an extra power unit if necessary.
		f. Circuit not properly suspended (loose or ineffective suspension).	Realign circuit. Check all suspensions and readjust where needed.



**DANGER**

**⚠ SWITCH OFF THE MAIN SWITCH OF THE CENTRAL CONTROL PANEL BEFORE YOU PROCEED WITH MANUAL CHECKS OR REPAIRS OF AUGERS OR POWER UNITS !**

**\* WHEN THE AUGER IS BLOCKED, PROCEED AS FOLLOWS :**

1. Put the main switch in position "Off".
2. Locate the blocking spot precisely.
3. Reload the motor protection (left or right).
4. Find the cause and correct. (See page 9 : 3., 4., 5. or 6.).
5. Put main switch in position "ON". The circuit is ready for a new feeding cycle.

## DAILY WINCHING

### GENERAL SAFETY RULES

Dagelijks lieren voor pluimvee

Daily winching for poultry

## IMPORTANT

Carefully read the following instructions before  
**USING** the system



**DANGER**

1. **PAY ATTENTION** when **WINCHING UP** or **PUTTING DOWN** the poultry lines:
  - **STOP** the handling in case of any malfunctioning.
  - **NEVER** stand **UNDERNEATH** the load when winching up or putting down the poultry lines.
2. **NEVER ALLOW UNAUTHORIZED PERSONS ENTER** the house during your absence.
3. **DON'T** wear **loose** clothing.
4. Only **adults** may control the motorized winch.
5. Only use the motorized winch for **suspension of a ROXELL poultry line and circuits**.
6. **ALWAYS** check the **condition of the motorized winch and the cable** before operating.  
A **ravelled, kinked or damaged cable** must be replaced **IMMEDIATELY**.  
A **loose or damaged daily winch** must be replaced **IMMEDIATELY**.
7. **ALWAYS** check before use, if the **cable** is ok.
8. **ALWAYS** check before use, if the **cable is not damaged**.
9. **NEVER** touch the **cable**, the **rotating parts** of the motorized winch and the **switches** of the switch assembly for automatic winch, when in use.
10. Only use the motorized winch when **NOBODY** is standing **underneath the load**.
11. **ALWAYS** look **at the load** while using the motorized winch in **manual mode**.
12. **PREVENT** that the load makes a **shocking movement**.
13. **COVER** the motorized winch during **cleaning**.



**FORBIDDEN: NEVER** use the motorized winch to lift persons.



**DANGER:** Getting jammed may cause **SERIOUS INJURIES**.

## DAILY WINCHING

### TROUBLE SHOOTING GUIDE

Not respecting above-mentioned instructions can cause physical injury or material damage.

Switch off the main switch first.

Use personal protective equipment.



**DANGER**

**ACTIONS IN GREY BACKGROUND MUST BE DONE BY A TECHNICALLY TRAINED PERSON.**



**DANGER**

**SEE TO IT THAT YOU FIRST REMOVE EACH ELEMENT WHICH CAN OBSTRUCT A SAFE OPERATION OF THE SYSTEM!**

PROBLEM	CAUSE	CORRECTIVE ACTION
1. Sensor doesn't work.	a. Defect of sensor.	- Replace the sensor.
	b. No power supply to sensor.	- Restore power supply. - When <b>not ok</b> , please ask a technically trained person.
	c. The housing is dirty.	- Clean the motorized winch dry. - When <b>not ok</b> , please ask a technically trained person.
2. Winching up doesn't work.	a. Load is too heavy.	- Limit the load till max. 300 kg.
	b. Cable to load is blocked somewhere.	- Release the cable.
	c. Motor is broken.	- Replace motor.
	d. Weight assembly is touching cleaning switch.	- Winch can only go down.
	e. Drop tubes to circuits are full.	- Empty drop tubes manually.
3. Putting down the load doesn't work.	a. Cable to load is blocked somewhere.	- Release the cable.
	b. Feeding switch is touched.	- Winch can only go up.
4. Motor doesn't work.	a. Motor is overloaded.	- Check CCP/motor.
	b. Motor is too warm.	- Check motor.
5. Cable is damaged.	a. Cable touches material.	- Replace the cable and prevent wearing over hard material.
	b. Suspension should be done with single/double diversion.	- Change suspension.

### MAINTENANCE INSTRUCTIONS



**DANGER**

**Switch off the main switch first.  
Use personal protective equipment.**

- Remove all dirt and dust after each batch or at least every 6 months.
- See to it that the winch turns fluently on the screw thread of the main shaft.
- Don't use water to clean the motorized winch.
- Use grease to grease moving parts.
- Check suspension cable each batch or every 6 months.
- Check the feed/fill/clean switches of the switch assembly.
- Grease switch assembly and sliding plate.
- Remove dust and dirt from the switch assembly for motorized winching.



**Inbouwverklaring betreffende niet voltooide machines (Richtlijn 2006/42/EG, Bijlage II.1.B)**  
**Declaration of incorporation of partly completed machinery (Directive 2006/42/EC, Annex II.1.B)**

Fabrikant/Manufacturer:  
Roxell BV, Industrielaan 13, 9990 Maldegem  
Tel: +32 50 72 91 72  
Fax: +32 50 71 67 21

Verklaart geheel onder eigen verantwoordelijkheid dat het product:  
Declares on its own responsibility that the product:

KiXoo/Vitoo/Boozter Nr: 008.../008.../002...  
Automatisch pannen voedersysteem voor opfok en productie van vleeskuikenunderdieren.  
Automatic pan feeding system for rearing and production of broiler breeders.

Waarop deze verklaring betrekking heeft, in overeenstemming is met:  
- de volgende richtlijnen: 2006/42/EG (Machinerichtlijn); 2014/30/EU (Elektromagnetische Compatibiliteit);  
- de geharmoniseerde Europese Normen: EN ISO 12100:2010; EN ISO 13854:2019; EN ISO 13857:2019; EN IEC 60204-1:2018; EN IEC 61439-1:2021; EN IEC 61439-2:2021.

**Het is verboden bovengenoemd product in gebruik te stellen voordat de machine waarin het wordt ingebouwd in overeenstemming met de bepalingen van de Machinerichtlijn is verklaard.**

Tevens verbindt de fabrikant (of zijn gemachtigde) zich om op met redenen omkleed verzoek van de nationale autoriteiten de relevante informatie over deze niet voltooide machine door te geven. De wijze van doorgifte is digitaal. De wijze van informatievervalsing laat de intellectueel-eigendomsrechten van de fabrikant van de niet voltooide machine onverlet.

(NL)

Relating to this declaration is in accordance with  
- The following directives 2006/42/EC (Machinery Directive); 2014/30/EU (Electromagnetic Compatibility).  
- The harmonised European standards: EN ISO 12100:2010; EN ISO 13854:2019; EN ISO 13857:2019; EN IEC 60204-1:2018; EN IEC 61439-1:2021; EN IEC 61439-2:2021.

**This product must not be put into service until the machinery into which it is to be incorporated has been declared in conformity with the provisions of the Machinery Directive.**

The manufacturer (or its agent) also undertakes, at the duly reasoned request of the national authorities, to provide the relevant information concerning this partly completed machinery. The method of transmission will be digital. The manner in which the information is provided does not prejudice the manufacturer's intellectual property rights concerning the partly completed machinery.

(EN)

00802603

Plaats, Datum / Place, Date: Maldegem, 01/01/2023

.....  
Dhr. Gino Van Landuyt  
Managing Director

"This part may only be filled out if all built-in subparts are delivered by Roxell"

**EG-verklaring van overeenstemming (Richtlijn 2006/42/EG, Bijlage I.1.A)**  
**EC-declaration of conformity (Directive 2006/42/EC, Annex II.1.A)**

Wij/We \_\_\_\_\_  
(naam installateur/name fitter)

\_\_\_\_\_  
(volledig adres en land/complete address)

Verklaren geheel onder eigen verantwoording de  
Declare completely on own justification that

\_\_\_\_\_  
(naam machine/name machinery) (nummer CE-label/number CE-label)

In een installatie te hebben ingebouwd geheel volgens de Roxell-voorschriften en in overeenstemming met de bepalingen van de Machinerichtlijn.  
Has been incorporated in conformity with the provisions of the Machinery Directive and the prescriptions of Roxell BV.

\_\_\_\_\_  
(plaats, datum/place, date) (naam, handtekening/name, signature)

De EG-verklaring van overeenstemming / inbouwverklaring betreft uitsluitend de machine of niet voltooide machine in de toestand waarin zij op de markt is gebracht, met uitsluiting van de later bijvoorbeeld door de verdeler en/of installateur en/of eindgebruiker toegevoegde componenten en/of verrichte bewerkingen.

The EC-declaration of conformity / declaration of incorporation relates exclusively to the machinery or partly completed machine in the state in which it was placed on the market and excludes components which are added and/or operations carried out thereafter for instance by the distributor and/or the installer and/or the final user.



**UK Declaration of Incorporation of partly completed machinery**  
Supply of Machinery (Safety) Regulations 2008

Manufacturer:

Roxell BV, Industrielaan 13, 9990 Maldegem

Tel: +32 50 72 91 72

Fax: +32 50 71 67 21

Declares on its own responsibility that the product:

KiXoo/Vitoo/Boozster Nr: 008.../008.../002...

Automatic pan feeding system for rearing and production of broiler breeders.

Relating to this declaration is in accordance with the essential requirements of

- The following Statutory Instruments:
  - o Supply of Machinery (Safety) Regulations 2008
  - o Electromagnetic Compatibility Regulations 2016
- The following Designated standards:

BS EN ISO 12100:2010; BS EN ISO 13854:2019; BS EN ISO 13857:2019; BS EN IEC 60204-1:2018; BS EN IEC 61439-1:2021; BS EN IEC 61439-2:2021.

**This product must not be put into service until the machinery into which it is to be incorporated has been declared in conformity with the provisions of the Machinery Directive.**

The manufacturer (or its agent) also undertakes, at the duly reasoned request of the national authorities, to provide the relevant information concerning this partly completed machinery. The method of transmission will be digital. The manner in which the information is provided does not prejudice the manufacturer's intellectual property rights concerning the partly completed machinery.

Place, Date: Maldegem, 01/01/2023

.....  
Dhr. Gino Van Landuyt  
Managing Director

"This part may only be filled out if all built-in subparts are delivered by Roxell"

**UK Declaration of Conformity**  
Supply of Machinery (Safety) Regulations 2008

We \_\_\_\_\_  
(name installer)

\_\_\_\_\_  
(complete address)

Declare completely on own justification that

\_\_\_\_\_ (name machinery) (number UKCA-marking)

has been incorporated in conformity with the provisions Supply of Machinery (Safety) Regulations 2008 and the prescriptions of Roxell BV.

\_\_\_\_\_ (place, date) (name, signature)

The UK Declaration of Conformity / Declaration of Incorporation relates exclusively to the machinery or partly completed machine in the state in which it was placed on the market and excludes components which are added and/or operations carried out thereafter for instance by the distributor and/or the installer and/or the end user.





**EG-verklaring van overeenstemming** (*Richtlijn 2006/42/EG, Bijlage II.1.A*)  
**EC-declaration of conformity** (*Directive 2006/42/EC, Annex II.1.A*)

Fabrikant/Manufacturer:  
Roxell BV, Industrielaan 13, 9990 Maldegem  
Tel: +32 50 72 91 72  
Fax: +32 50 71 67 21

Verklaart geheel onder eigen verantwoordelijkheid dat het product:  
Declares on its own responsibility that the product:

Winching system Nr: 00102368 / 00102087  
Liersysteem voor voer- en drinklijnen; manueel en gemotoriseerd  
Winching system for feed- and drink lines; manual and motorised  
Nummer CE-label/number CE-label : \_\_\_\_\_

Waarop deze verklaring betrekking heeft, in overeenstemming is met:

- de volgende richtlijnen: 2006/42/EG (Machinerichtlijn); 2014/30/EU (Elektromagnetische Compatibiliteit);
- de geharmoniseerde Europese Normen: EN ISO 12100:2010; EN ISO 13854:2019; EN ISO 13857:2019; gemotoriseerd: EN IEC 60204-1:2018; EN IEC 61439-1:2021; EN IEC 61439-2:2021.

De EG-verklaring van overeenstemming / inbouwverklaring betreft uitsluitend de machine of niet voltooide machine in de toestand waarin zij op de markt is gebracht, met uitsluiting van de later door bijvoorbeeld de verdeler en/of installateur en/of eindgebruiker toegevoegde componenten en/of verrichte bewerkingen.

**(NL)**

Relating to this declaration is in accordance with

- The following directives 2006/42/EC (Machinery Directive); 2014/30/EU (Electromagnetic Compatibility).
- The harmonised European standards: EN ISO 12100:2010; EN ISO 13854:2019; EN ISO 13857:2019; motorised: EN IEC 60204-1:2018; EN IEC 61439-1:2021; EN IEC 61439-2:2021.

The EC-declaration of conformity / declaration of incorporation relates exclusively to the machinery or partly completed machine in the state in which it was placed on the market and excludes components which are added and/or operations carried out thereafter for instance by the distributor and/or the installer and/or the final user.

**(EN)**

Plaats, Datum / Place, Date: Maldegem, 01/01/2023

.....  
Dhr. Gino Van Landuyt  
Managing Director



## UK Declaration of Conformity

Supply of Machinery (Safety) Regulations 2008

Manufacturer:

Roxell BV, Industrielaan 13, 9990 Maldegem

Tel: +32 50 72 91 72

Fax: +32 50 71 67 21

Declares on its own responsibility that the product:

Winching system Nr: 00102368 / 00102087

Winching system for feed- and drink lines; manual and motorised

Number UKCA-marking: \_\_\_\_\_

Relating to this declaration is in accordance with the essential requirements of

- The following Statutory Instruments:
  - o Supply of Machinery (Safety) Regulations 2008
  - o Electromagnetic Compatibility Regulations 2016
- The following Designated standards:

BS EN ISO 12100:2010; BS EN ISO 13854:2019; BS EN ISO 13857:2019; BS EN IEC 60204-1:2018; BS EN IEC 61439-1:2021; BS EN IEC 61439-2:2021.

The UK Declaration of Conformity / Declaration of Incorporation relates exclusively to the machinery or partly completed machine in the state in which it was placed on the market and excludes components which are added and/or operations carried out thereafter for instance by the distributor and/or the installer and/or the end user.

Place, Date: Maldegem, 01/01/2023

.....  
Dhr. Gino Van Landuyt  
Managing Director





ROXELL BV - Industrielaan 13, 9990 Maldegem (Belgium)  
Tel. +32 50 72 91 72 - [info@roxell.com](mailto:info@roxell.com) - [www.roxell.com](http://www.roxell.com)

ROXELL USA Inc. - 720 Industrial Park Road, Anderson MO 64831 (USA)  
Tel. +1 417 845 6065 - [info.usa@roxell.com](mailto:info.usa@roxell.com) - [www.roxell.com](http://www.roxell.com)

ROXELL Malaysia - No. 49, Jalan Permata 2/KS9, Taman Perindustrian Air Hitam, 41200 Klang, Selangor (Malaysia)  
Tel. +60 3 3123 1767 - [info.malaysia@roxell.com](mailto:info.malaysia@roxell.com) - [www.roxell.com](http://www.roxell.com)

ROXELL Россия - ООО «Рокселл» ОГРН 1157746055026  
123060, Россия, город Москва, улица Маршала Рыбалко, дом 2, корпус 9, офис 909.1  
Телефон: +7 495 983 30 15 - Адрес электронной почты: [info.russia@roxell.com](mailto:info.russia@roxell.com) - [www.roxell.com](http://www.roxell.com)